

**Cofer Bros., Inc.**

SINCE 1919...MORE THAN JUST A LUMBER YARD

*Building Supply Professionals ~ Community Partners*



# Moulding Catalog

Sixth Edition

**2300 Main Street Tucker, GA (770) 938-3200**

**[www.coferbrothers.com](http://www.coferbrothers.com)**

## NUMERICAL INDEX

PART NO.	PART NAME	MATERIAL	SIZES	PAGE NO.
CB 2	APRON	FJ, A, MDF	11/16" x 2 1/2"	1, 2, 3,15
CB 5	CAP MOULD	A	3/4" x 1 1/4"	15
CB 1001	CHAIR RAIL	FJ, A	11/16" x 2 3/4"	15
CB 600	BEADED BACK PLATE	FJ, A	1/2" x 4 3/8"	15
CB 300	CHAIR RAIL	FJ	1 1/16" x 3"	15
CB 74	BED MOULDING	FJ	7/16" x 1 3/4"	5
CB 60	CROWN MOULDING	A	9/16" x 1 3/4"	5
CB 52	CROWN MOULDING	FJ, A	9/16" x 2 3/4"	5
CB 49	CROWN MOULDING	FJ, A, MDF	11/16" x 3 5/8"	6
CB 47	CROWN MOULDING	FJ, A, MDF	11/16" x 4 5/8"	1, 3, 6
CB 500	DENTIL CROWN MOULDING	FJ, A	11/16" x 3 11/16"	6
CB 17	CROWN MOULDING	FJ, A, MDF	11/16" x 5 5/8"	7
CB 7	DENTIL CROWN MOULDING	FJ	1 1/16" x 5 1/2"	2, 7
CB 707	DENTIL	A	11/16" x 1 5/16"	2, 8
CB 500	DENTIL	A	1/2" x 5/8"	8
CB 525FJ	CROWN MOULDING	FJ	3/4" x 5 3/8"	7
CB 205	CORNER MOULD	A	1 1/8" x 1 1/18"	16
CB 206	CORNER MOULD	A	11/16" x 11/16"	16
CB 106	QUARTER ROUND	A	11/16" x 11/16"	16
CB 129	SHOE MOLD	A, OAK, FJ	7/16" x 11/16"	4, 16
CB 937	STOP	A	7/16" x 1 1/4"	16
CB 935	STOP	A	7/16" x 1 5/8"	16
CB 142	SCREEN MOULD	A	1/4" x 3/4"	16
CB 941	STOP	A	7/16" x 3/4"	16
CB 100	COVE MOULD	A	11/16" x 11/16"	16
CB 995	CHAMFER STRIP	A	3/4" x 3/4"	16
CB 260	LATTICE	A	1/4" x 1 1/2"	16
CB 105	OAK QUARTER ROUND	OAK	3/4" x 3/4"	16
CB 24	RETURN NOSING	OAK	1" x 1 1/4"	18
CB 233	CLOSET ROD	A	1 1/4"	18
CB 23	LANDING NOSING	OAK	1" x 3 1/2"	18
CB 23A	LANDING NOSING	OAK	1" x 5 1/4"	18
CB 240	OVAL HANDRAIL	FJ, A	1 1/4" x 2 1/4"	18
CB 273	PICTURE MOULD	FJ, A	11/16" x 1 3/4"	3, 17
CB 163	BASE CAP	FJ, A	3/4" x 1 1/2"	4, 17
CB 22	MULL CASING	A	3/4" x 1 1/2"	17
CB 988	MULL CASING	A	3/8" x 1 3/8"	17
CB 988	MULL CASING	A	3/8" x 2"	17
CB 37	JOINT MOULD	A	3/8" x 3/4"	17
CB 137	JOINT MOULD	FJ	9/16" x 1 1/4"	1, 17
CB SP3 383	BACK BAND	FJ	1 1/4" x 1 7/8"	14
CB 289	BACK BAND	A	1 1/8" x 2"	14
CB 288	BACK BAND	A	1" x 1 5/8"	14
CB 281	BACK BAND	A	11/16" x 1 1/8"	14
CB 281	BACK BAND	FJ	1 5/16" x 1 3/8"	14
CB 280	BACK BAND	A	11/16" x 1 1/8"	14
CB 1200	BACK BAND	FJ	1 1/2" x 2"	14
CB 42	PANEL MOULD	FJ, A	1 1/16" x 1 5/8"	21
CB 43R	PANEL MOULD	FJ, A	1 7/8"	21
CB 42R	PANEL MOULD	FJ, A	1 1/16" x 1 5/8"	4, 21
CB 20	MANTEL MOULD	A	1 7/16" x 5 7/16"	21

## NUMERICAL INDEX

PART NO.	PART NAME	MATERIAL	SIZES	PAGE NO.
CB 27	PLINTH MATERIAL	A	11/16" x 2 1/2"	1, 2, 3,15
CB 3 SP3	PLINTH BLOCK	FJ	3/4" x 1 1/4"	15
CB 306	PLINTH BLOCK	POPLAR	11/16" x 2 3/4"	15
CB 408	PLINTH BLOCK	FJ	1/2" x 4 3/8"	15
CB 187	DRIP CAP	A	1 1/16" x 3"	15
CB 197	DRIP CAP	A	7/16" x 1 3/4"	5
CB 1206	RAKE MOLD	VINYL	9/16" x 1 3/4"	5
CB 180	BRICK MOLD	FJ	9/16" x 2 3/4"	5
AW 14BB	ALL WEATHER COMBO	FJ, A	11/16" x 3 5/8"	6
CB 134	T-ASTRAGAL		11/16" x 4 5/8"	1, 3, 6
CB 138	T-ASTRAGAL		11/16" x 3 11/16"	6
CB 618	BASE	FJ, A	11/16" x 5 5/8"	7
CB 620	BASE	FJ, A, MDF	1 1/16" x 5 1/2"	2, 7
CB 623	BASE	FJ, A, MDF	11/16" x 1 5/16"	2, 8
CB 167	BASE	FJ, MDF	1/2" x 5/8"	8
CB 713	BASE	FJ, A	1 1/8" x 1 1/18"	16
9" MDF BASE	BASE	MDF	11/16" x 11/16"	16
CB 616	VICTORIAN BASE	FJ	11/16" x 11/16"	16
CB 324	CASING	FJ, A	7/16" x 11/16"	4, 16
CB 366	CASING	FJ	7/16" x 1 1/4"	16
CB 5205	CASING	FJ, A	7/16" x 1 5/8"	16
CB 356	CASING	FJ, A	1/4" x 3/4"	16
CB 601	CASING	WP, FJ	16' x 3/4" x 11/16"	11
CB 3	CASING	FJ, A	7/16" x 3/4"	16
CB 3 BABY	CASING	FJ, A	11/16" x 11/16"	16
CB 304	MDF CASING	MDF	3/4" x 3/4"	16
CB 1000	FLUTED CASING	FJ, A	1/4" x 1 1/2"	16
CB 1000B	FLUTED CASING	FJ	3/4" x 3/4"	16
CB 1000B	FLUTED CASING	FJ	1" x 1 1/4"	18
CB 30	ROSETTE		1 1/4"	18
CB 35	ROSETTE		1" x 3 1/2"	18
	WINDOW SUBSILL		1" x 5 1/4"	18
	WINDOW EXTENSION JAMB		1 1/4" x 2 1/4"	18
CB 1077	WINDOW STOOL	A	11/16" x 1 3/4"	3, 17
CB 1195	WINDOW STOOL	FJ, A	3/4" x 1 1/2"	4, 17
CB 26	WINDOW STOOL	FJ, A	3/4" x 1 1/2"	17
	WINDOW SILL	COMPOSITE	3/8" x 1 3/8"	17
	DOUBLE RABBIT JAMB	FJ	3/8" x 2"	17
	EXTERIOR DOOR JAMB	FJ	3/8" x 3/4"	17
	EXTERIOR DOOR SILL	OAK	9/16" x 1 1/4"	1, 17
	ALL WEATHER MULL	PVC	1 1/4" x 1 7/8"	14
	ALL WEATHER DOOR MULL	PVC	1 1/8" x 2"	14
	TRANSON MULL	PVC	1" x 1 5/8"	14
	2 FILLER	PVC	11/16" x 1 1/8"	14
	DH DARTING BEAD	AWP	11/16" x 1 1/8"	14
	DH TILT STOP	AWP	1 1/2" x 2"	14
	ALL WEATHER BLIND STOP	PVC	1 1/16" x 1 5/8"	21

# CEILING ASSEMBLY

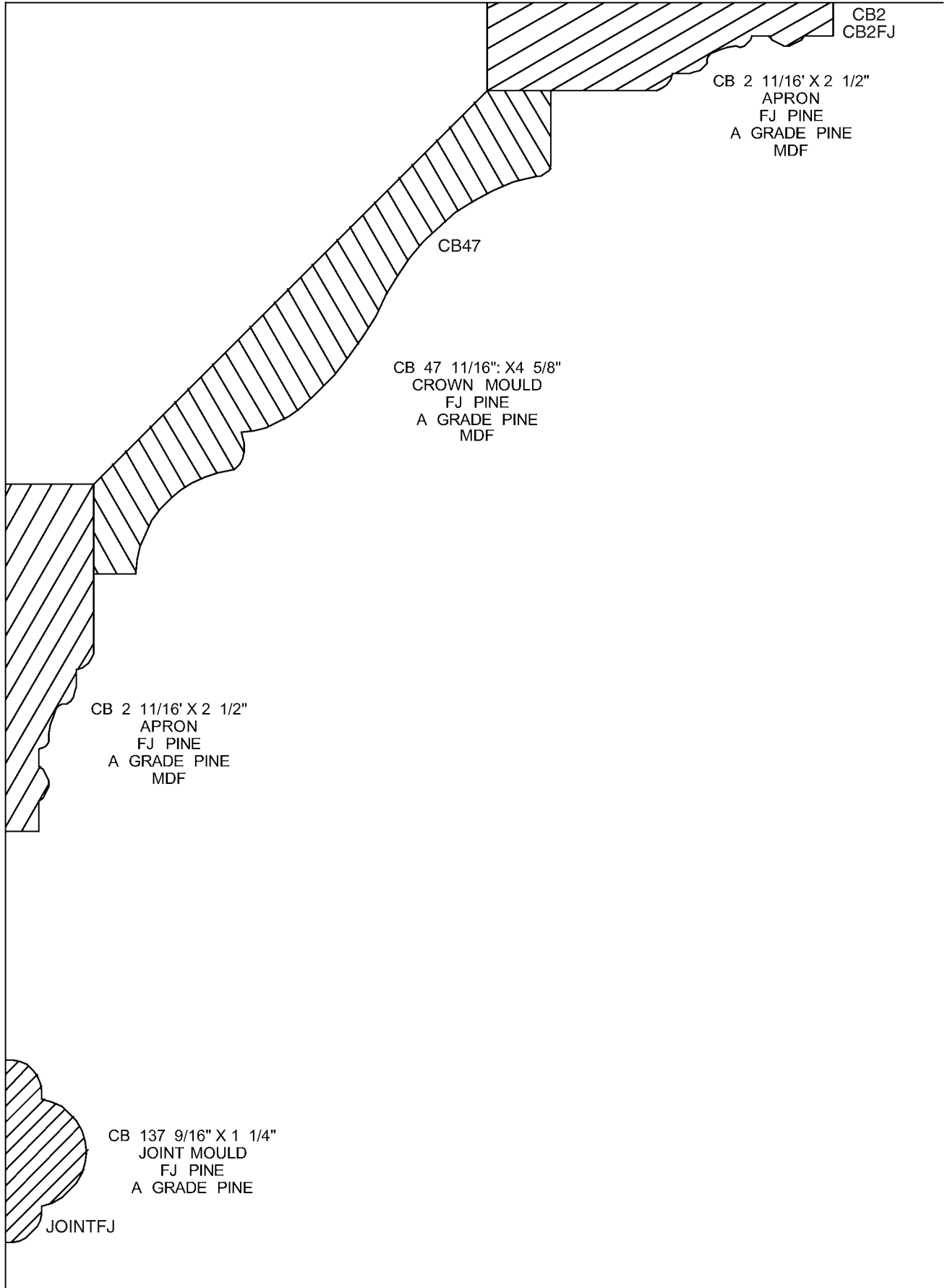

# CEILING ASSEMBLY

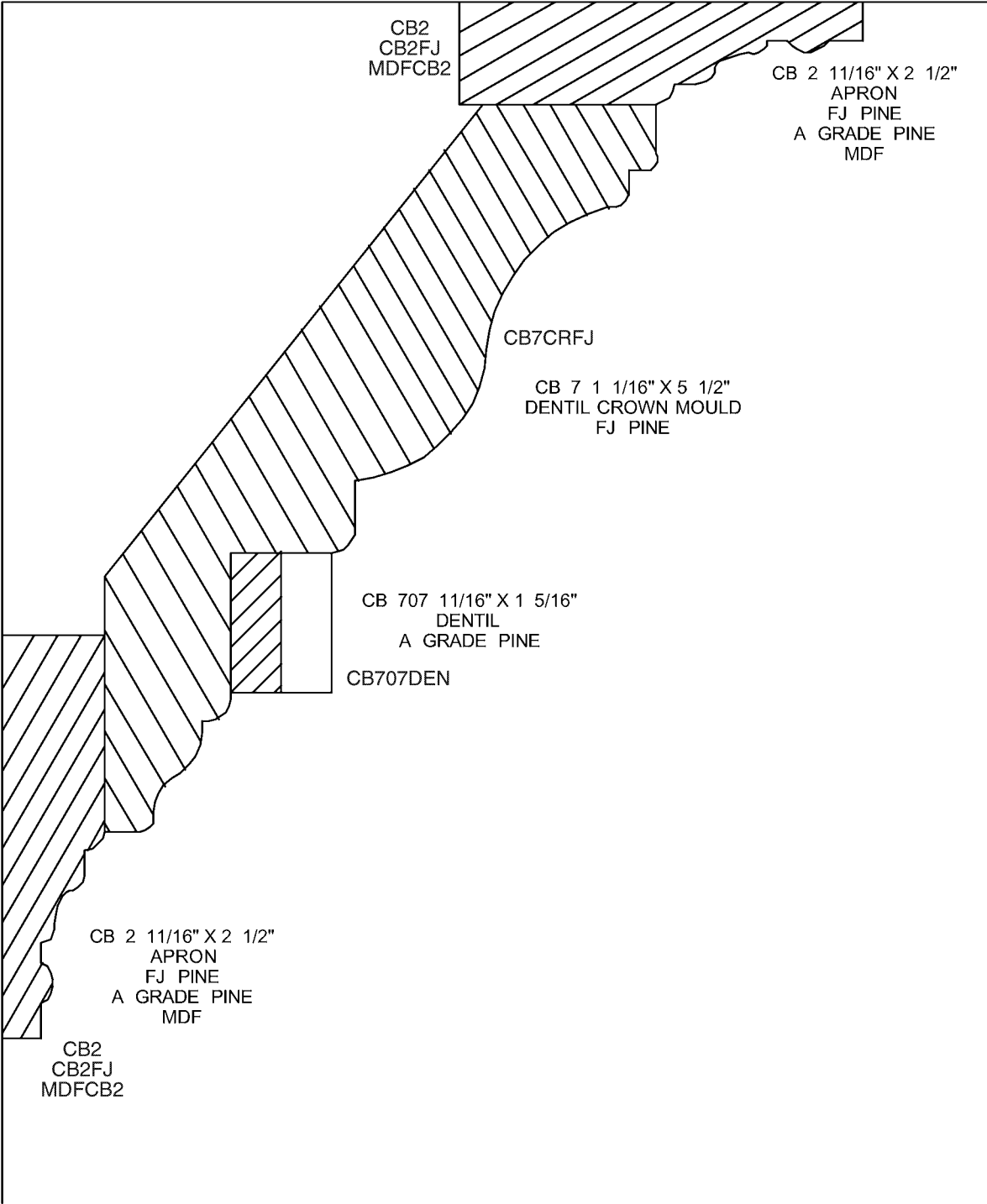

# CEILING ASSEMBLY

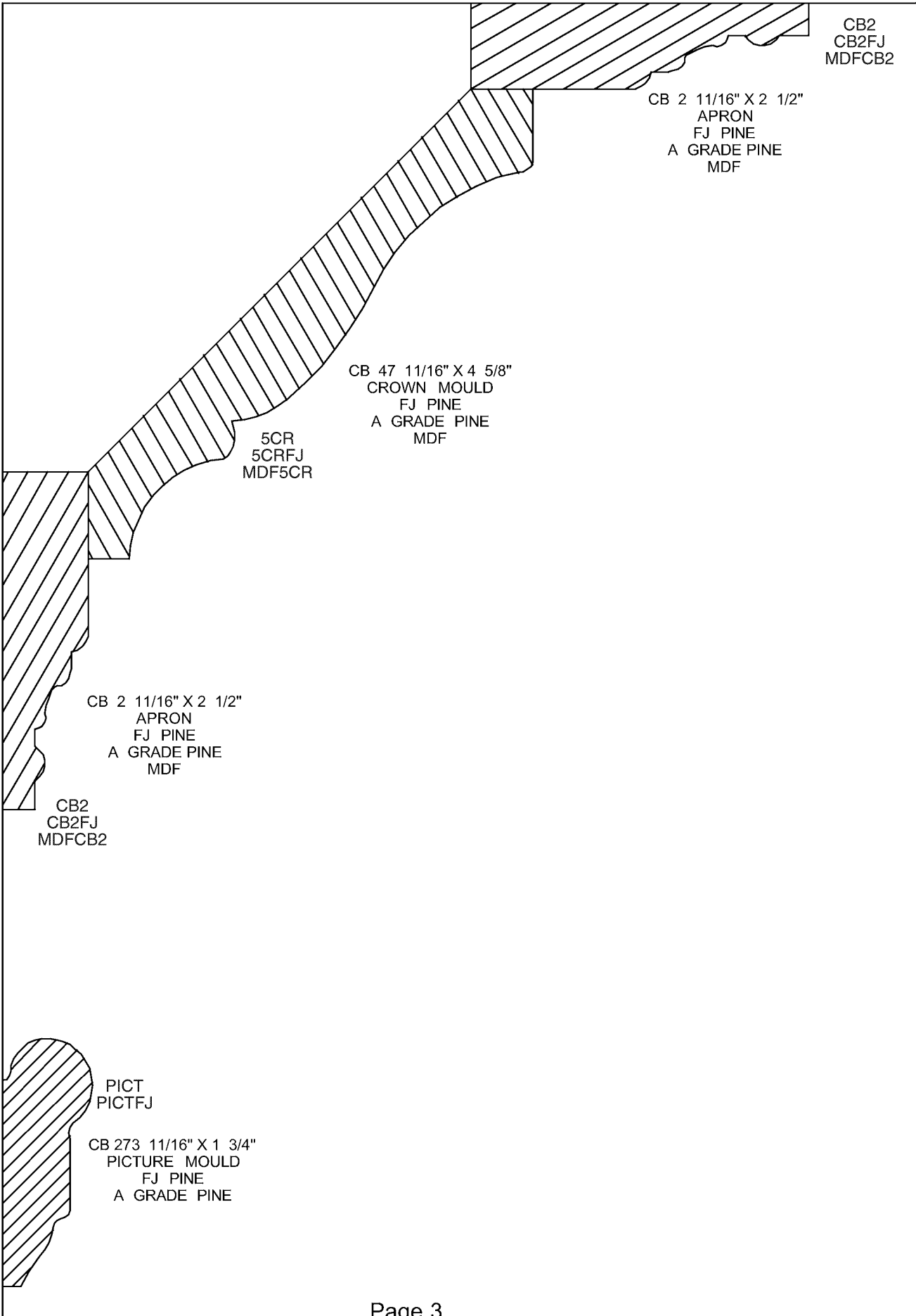

# ASSEMBLIES

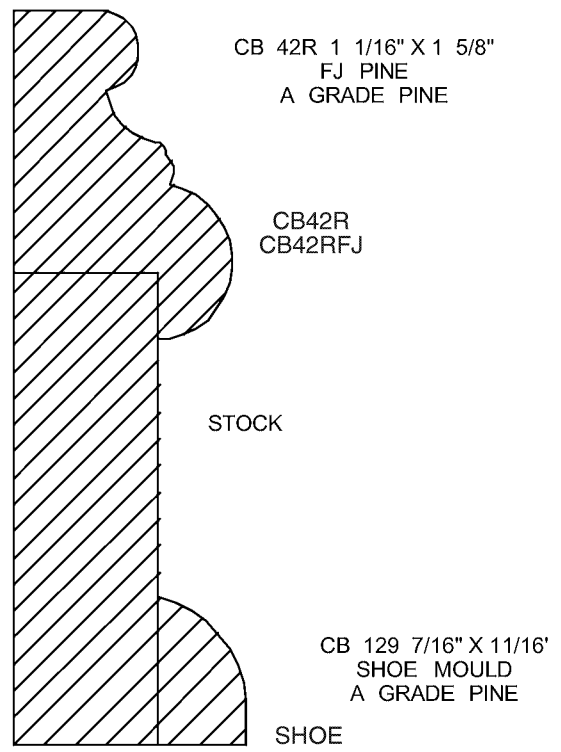
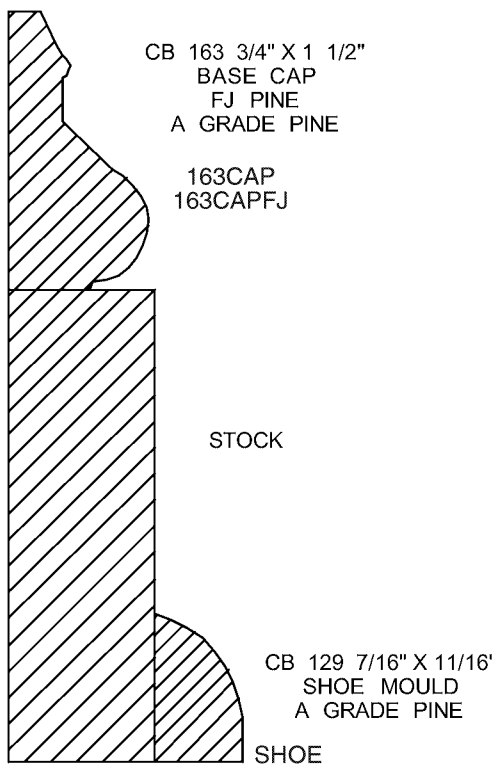

# BED MOULDING AND CROWN MOULDING

RISE 1 7/16"  
PROJECTION 1 1/8"

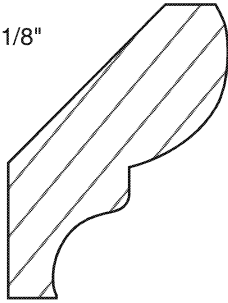

BED MLD

CB 74 7/16" X 1 3/4"  
BED MOULD  
FJ PINE

## 2" BED MOULDING

RISE 1 3/8"  
PROJECTION 1 1/16"

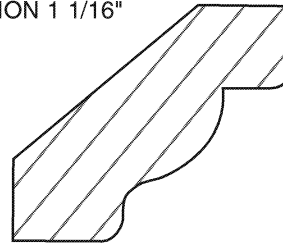

2CR

CB 60 9/16" X 1 3/4"  
CROWN MOULD  
A GRADE PINE

## 2" CROWN MOULDING

RISE 2 1/4"  
PROJECTION 1 7/8"

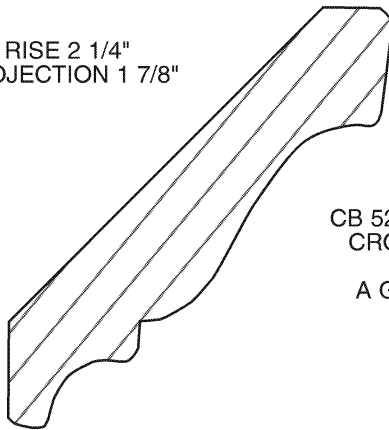

CB 52 9/16" X 2 3/4"  
CROWN MOULD  
FJ PINE  
A GRADE PINE

3CR  
3CRFJ

## 3" CROWN MOULDING



# CROWN MOULDING

RISE 3"  
PROJECTION 2"

4CR  
4CRFJ  
4CRFJP  
MDF4CR

CB 49 11/16" X 3 5/8"  
CROWN MOULD  
FJ PINE  
A GRADE PINE  
MDF  
PVC

4" CROWN MOULDING

RISE 3 11/16"  
PROJECTION 2 3/4"

CB 47 11/16" X 4 5/8"  
CROWN MOULD  
FJ PINE  
A GRADE PINE  
MDF

5" CROWN MOULDING

5CR  
5CRFJ  
MDF5CR

RISE 2 9/16"  
PROJECTION 2 1/16"

CB 500 11/16" X 3 11/16"  
DENTIL CROWN MOULD  
FJ PINE  
A GRADE PINE

RABCRFJ  
RABCR

# CROWN MOULDING

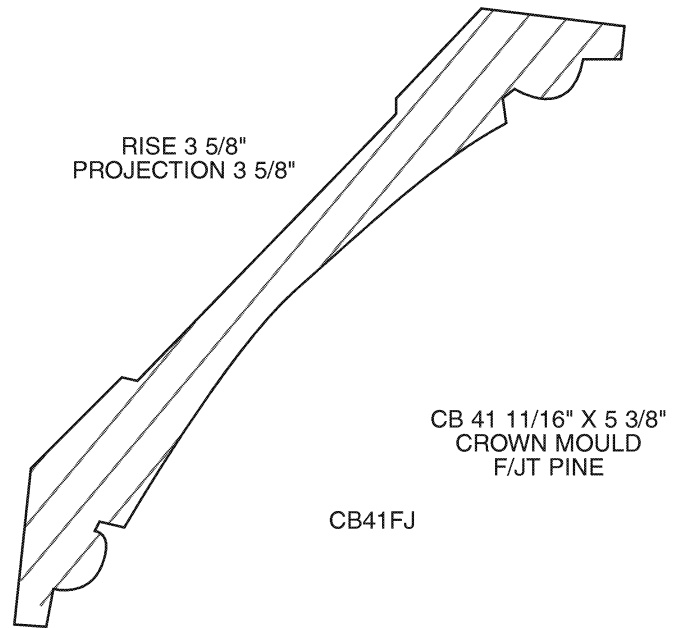
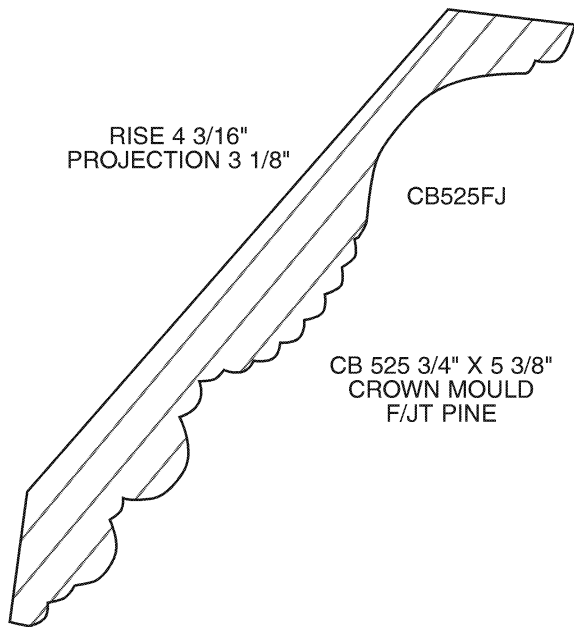
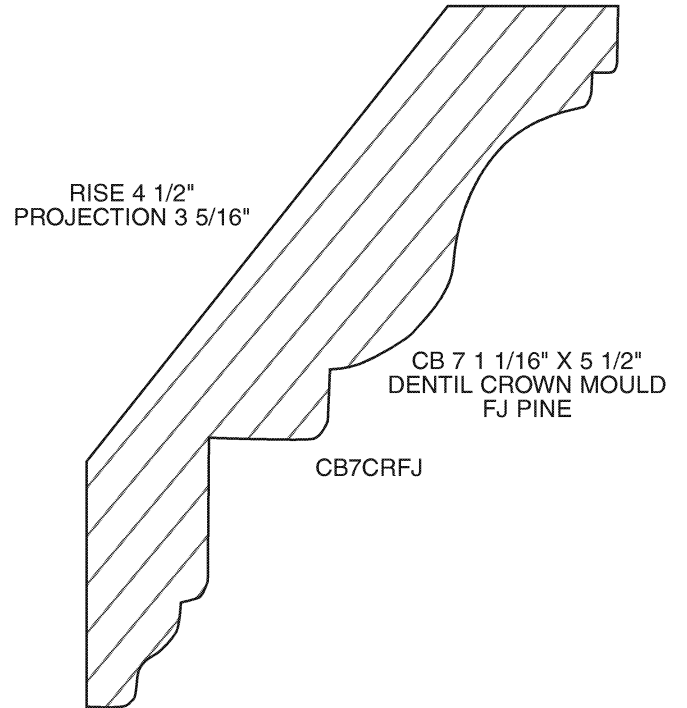
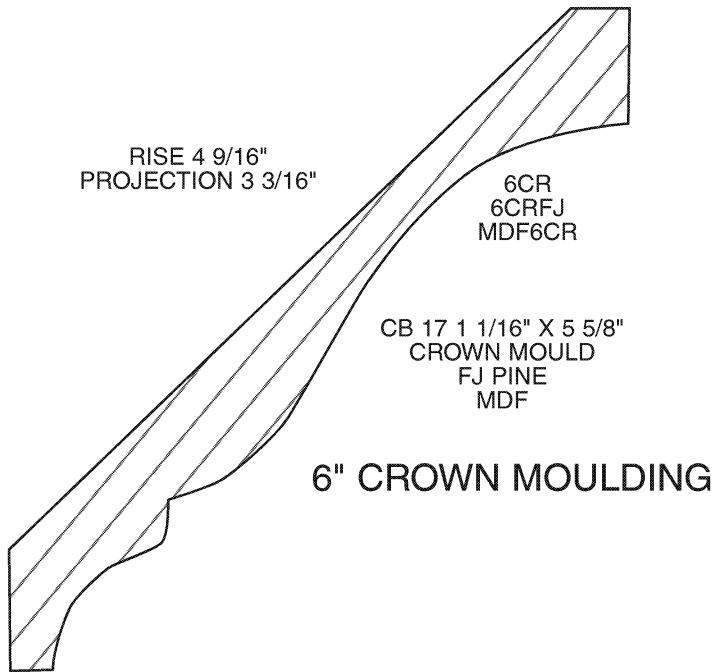

# DENTILS

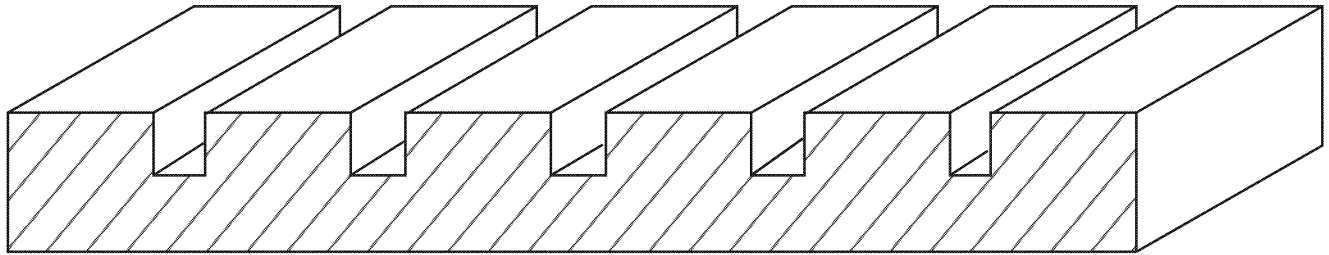

CB707DENT

CB 707 11/16" X 1 5/16"  
DENTIL  
A GRADE PINE

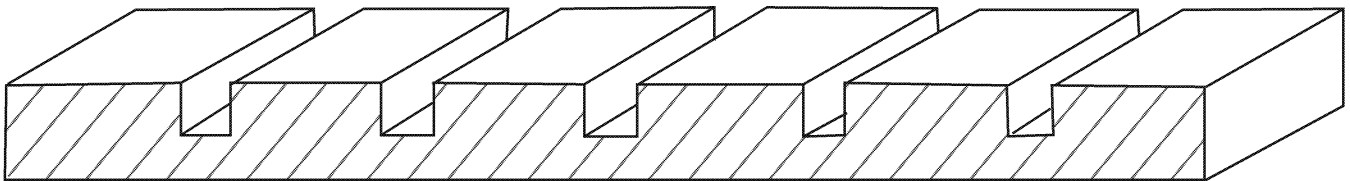

CB500DENT

CB 500 1/2" X 5/8"  
DENTIL  
A GRADE PINE

# BASES

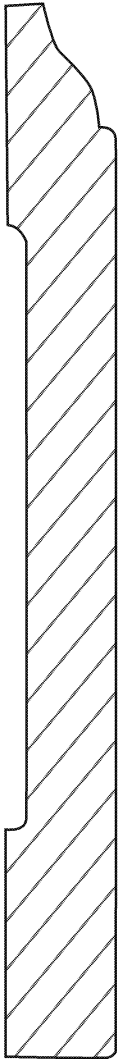

CB 618 9/16" X 5 1/4"  
BASE MOULD  
FJ PINE  
A GRADE PINE

5BASE  
5BASEFJ

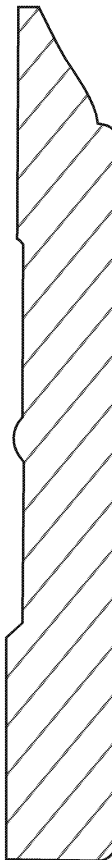

CB 620 9/16" X 4 1/4"  
BASE MOULD  
FJ PINE  
A GRADE PINE  
MDF

4BASE  
4BASEFJ  
MDF4BASE

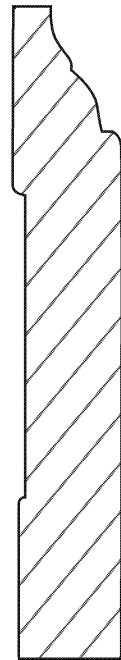

CB 623 9/16" X 3 1/4"  
BASE MOULD  
FJ PINE  
A GRADE PINE  
MDF

3BASE  
3BASEFJ  
MDF3BASE

# BASES

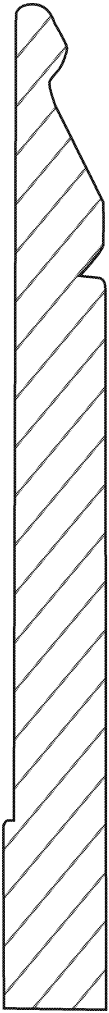

CB 167 9/16" X 5 1/4"  
SPEED BASE  
FJ PINE  
MDF

SPDBASE  
MDF5BASE

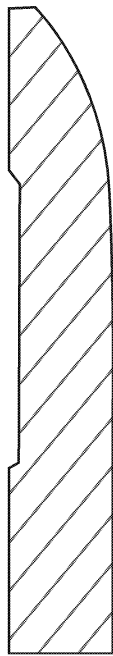

CB 713 9/16" X 3 1/4"  
TEAR DROP BASE  
FJ PINE  
A GRADE PINE

TDBASE  
TDBASEFJ

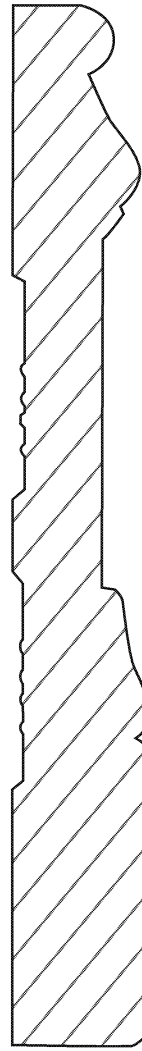

CB 616 11/16" X 5 1/4"  
VICTORIAN BASE  
FJ PINE

VICTBASE

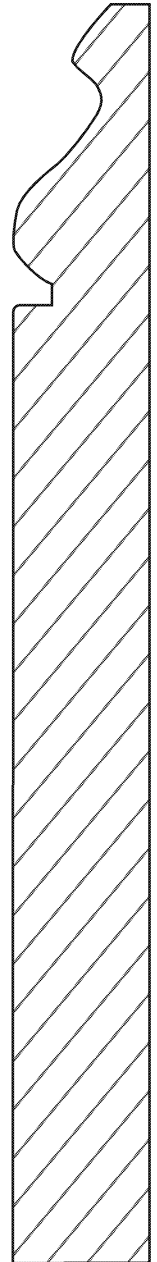

3/4" X 8 11/16"  
9" MDF BASE

MDF9BASE

# CASINGS

CB 324 11/16" X 2 1/4"  
TD CASING  
FJ PINE  
A GRADE PINE

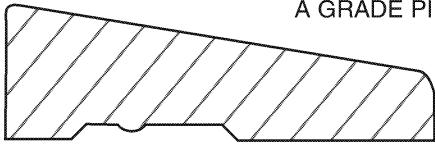

TDCSG  
TDCSGFJ

CB 366 11/16" X 2 1/4"  
CASING  
FJ PINE

366CSGFJ

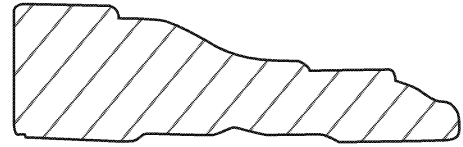

CB 5205 11/16" X 3 1/4"  
CASING  
FJ PINE  
A GRADE PINE

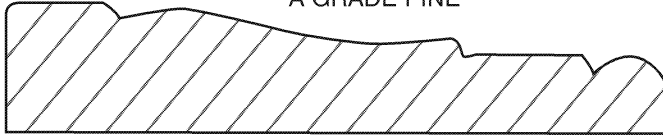

5205CSG  
5205FJ

CB 356 11/16" X 2 1/4"  
CASING  
FJ PINE  
A GRADE PINE

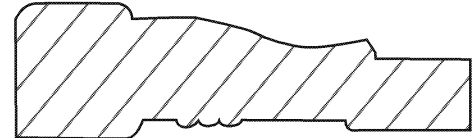

356CSG  
356CSGFJ

CB 3 BABY 11/16" X 2 1/4"  
CASING  
FJ PINE

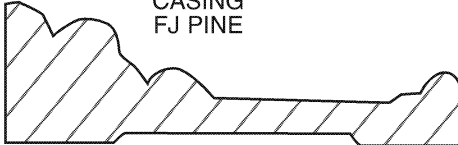

BABYCB3

CB 3 1 1/16" X 3 1/2"  
CASING  
FJ PINE  
A GRADE PINE

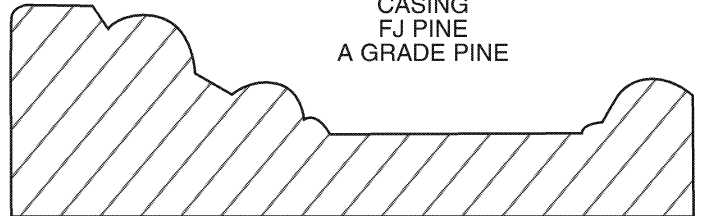

CB3  
CB3FJ

CB 101 11/16" X 3 1/2"  
CASING  
F/JT PINE

CB101FJ

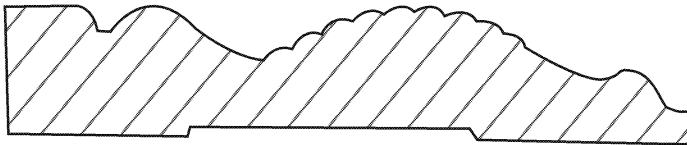

CB 601 16' X 4 3/4" X 11/16"  
WP/FJ

CB601CSG

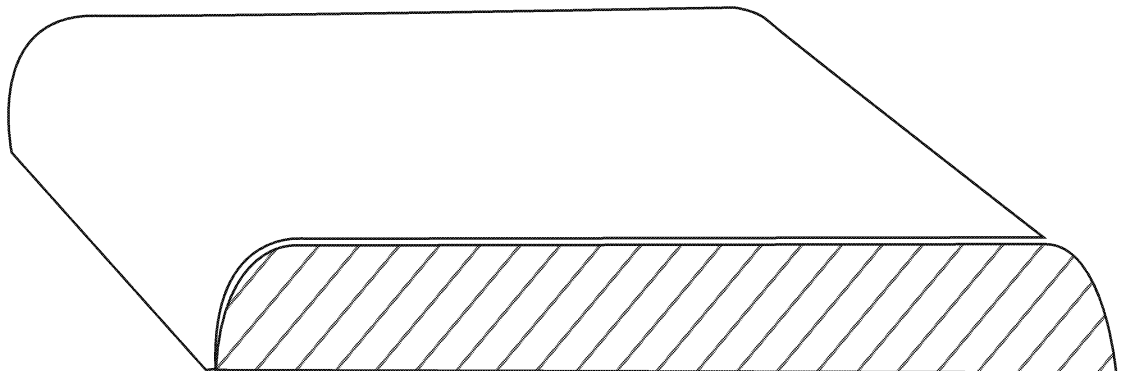

# FLUTED CASINGS

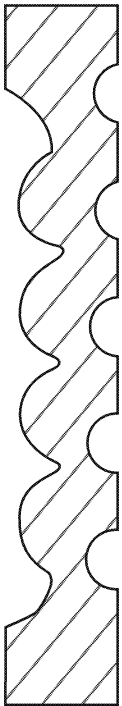

CB 1000 11/16" X 3 1/2"  
FLUTED CASING  
FJ PINE  
A GRADE PINE

FLCSG  
FLCSGFJ

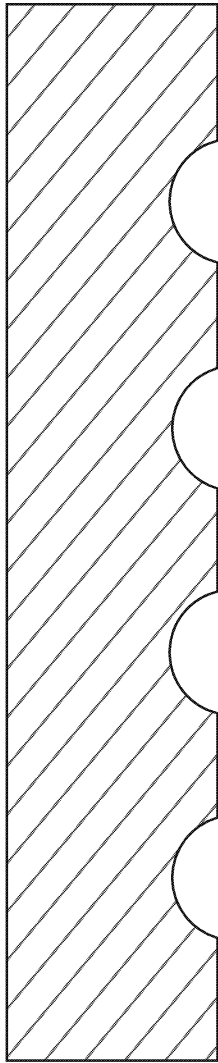

CB 1000B 1 1/8" X 5 1/4" X 90"  
FLUTED CASING  
FJ PINE

514FLCSG

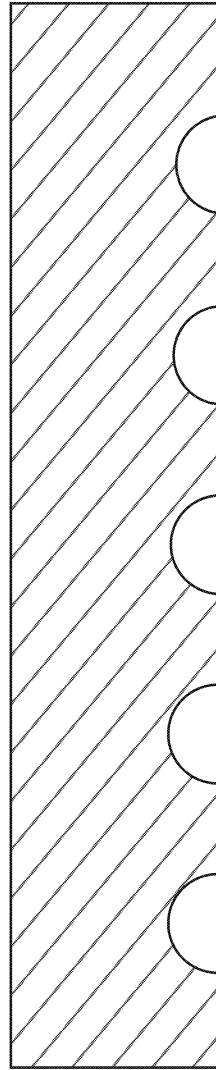

CB 1000B 1 1/8" X 5 1/4" X 16'  
FLUTED CASING  
FJ PINE

5FLCSG16

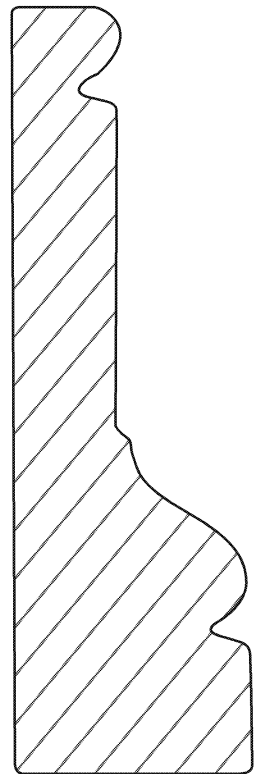

CB 304 1 1/4" X 4 1/16"  
MDF CASING

MDF304

# ROSETTES

CB 30 3 3/4" X 3 3/4"

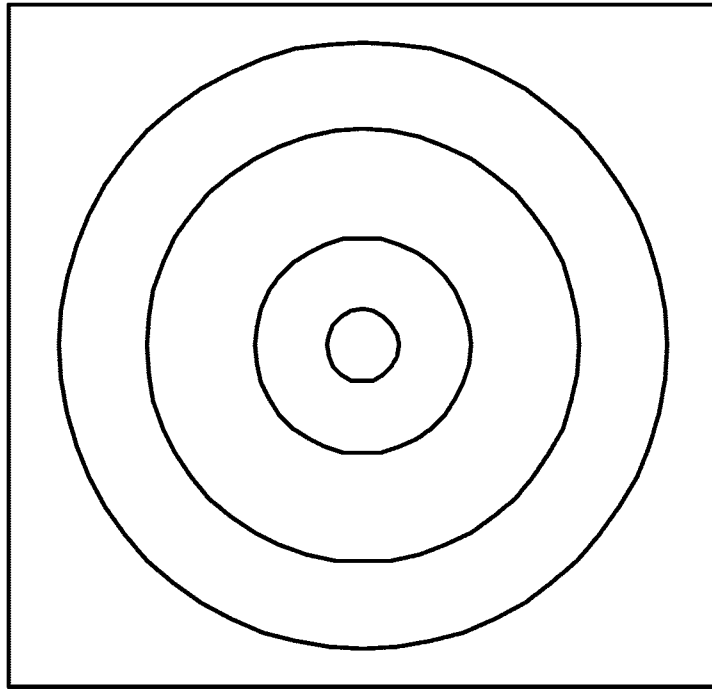

CB 35 5 1/2" X 5 1/2"

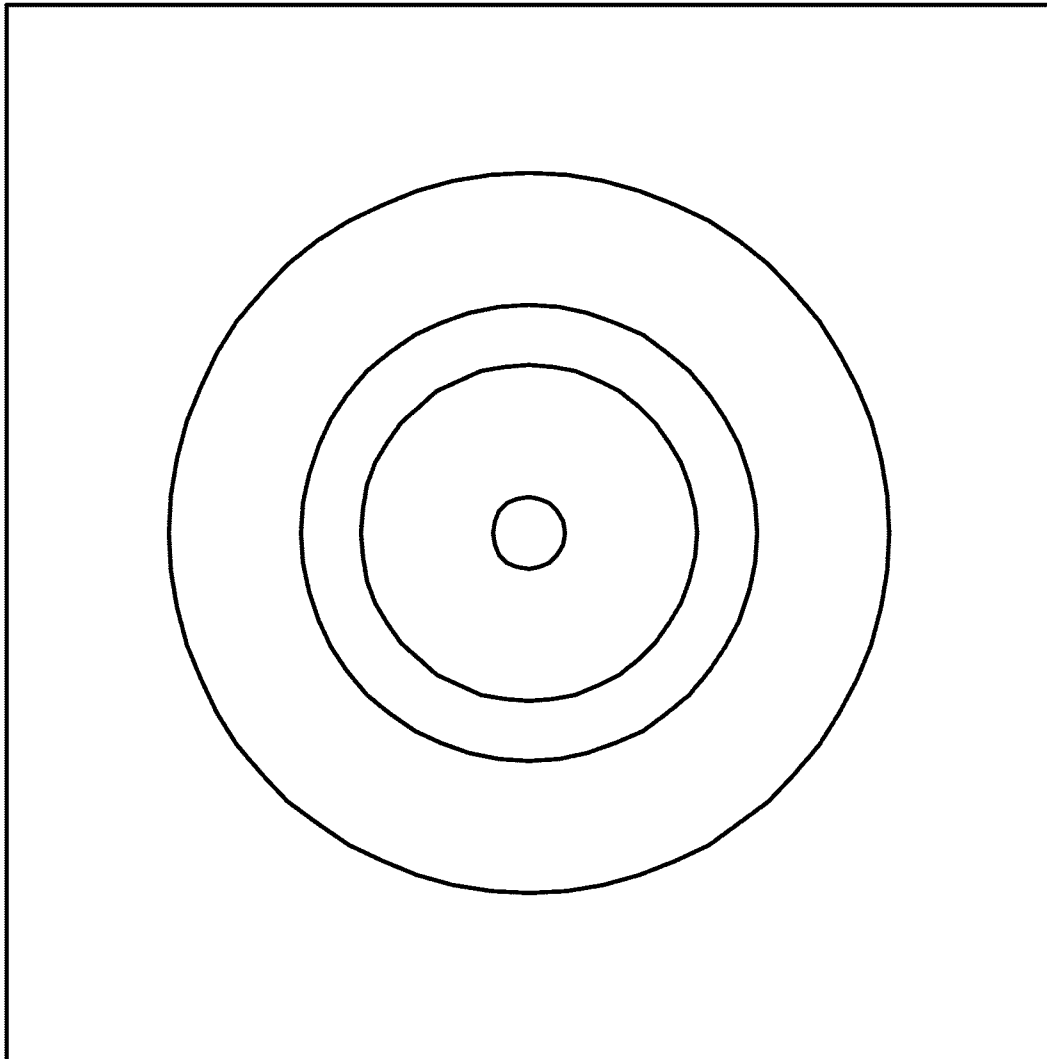



# BACK BANDS

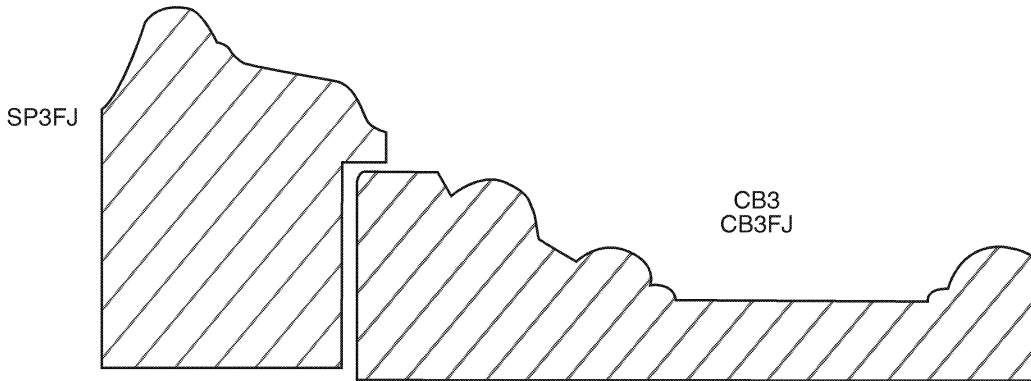

CB SP3 383 1 X 1 7/8"  
BACK BAND  
FJ PINE

CB 3 1 1/16" X 3 1/2"  
CASING  
FJ PINE  
A GRADE PINE

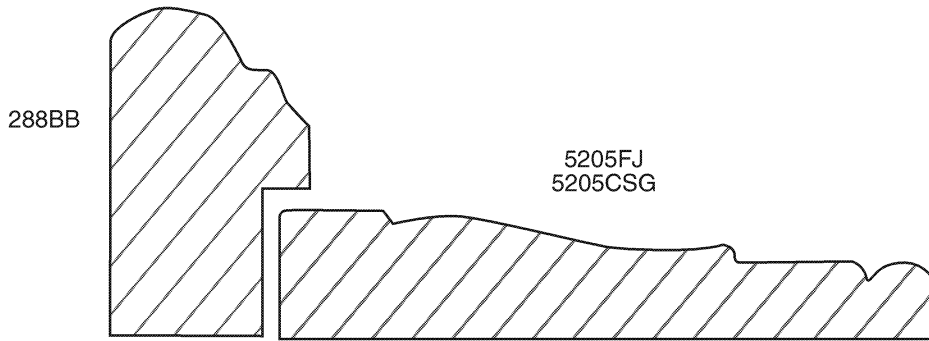

CB 288 11/16" X 1 5/8"  
BACK BAND  
A GRADE PINE

CB 5205 11/16" X 3 1/4"  
CASING  
FJ PINE  
A GRADE PINE

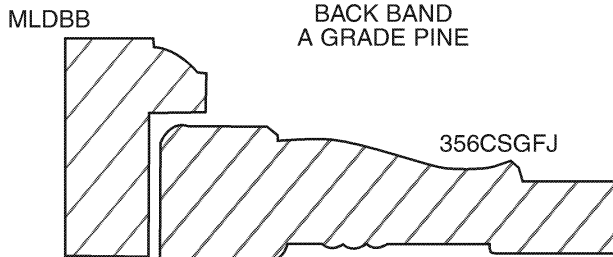

CB 281 11/16" X 1 1/8"  
BACK BAND  
A GRADE PINE

CB 356 11/16" X 2 1/4"  
CASING  
FJ PINE  
A GRADE PINE

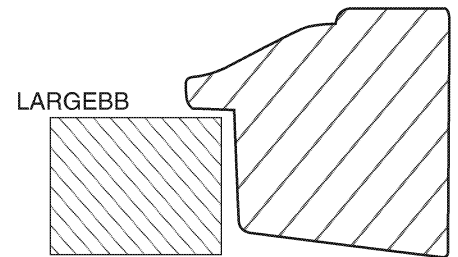

Large BB  
1 5/16" X 1 3/8"

F/J 281  
BACKBAND

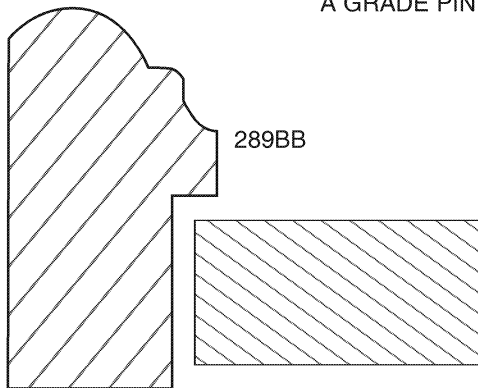

CB 289 1 1/8" X 2"  
BACK BAND  
A GRADE PINE

CB 280 11/16" X 1 1/8"  
BACK BAND  
A GRADE PINE

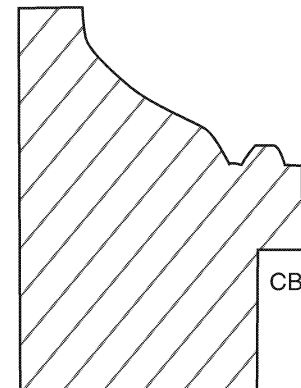
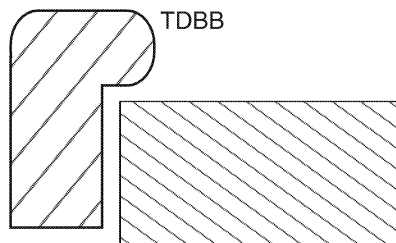

CB 1200 1 1/12" X 2"  
11/16 RABBET  
BACK BAND  
FJ PINE

# CHAIR RAIL, CAP MOULDING AND APRON

## CAP MOULD

CB 5 3/4" X 1 1/4"  
A GRADE PINE  
FJ PINE

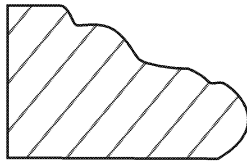

CB5  
CB5FJ

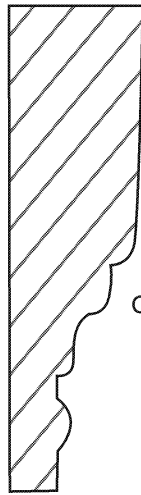

CB2FJ  
MDFCB2

CB 2 11/16" X 2 1/2"  
APRON MOULD  
FJ PINE  
A GRADE PINE  
MDF

## APRON

CB 600 1/2" X 4 3/8"  
BEADED BACK PLATE  
FJ PINE  
A GRADE PINE

CB600  
CB600FJ

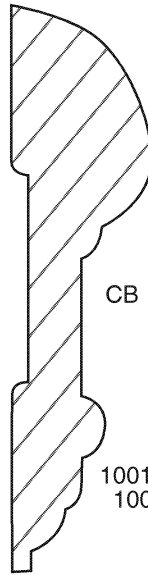

CB 1001 1 1/16" X 2 3/4"  
CHAIR RAIL  
FJ PINE  
A GRADE PINE

1001CRFJ  
1001CR

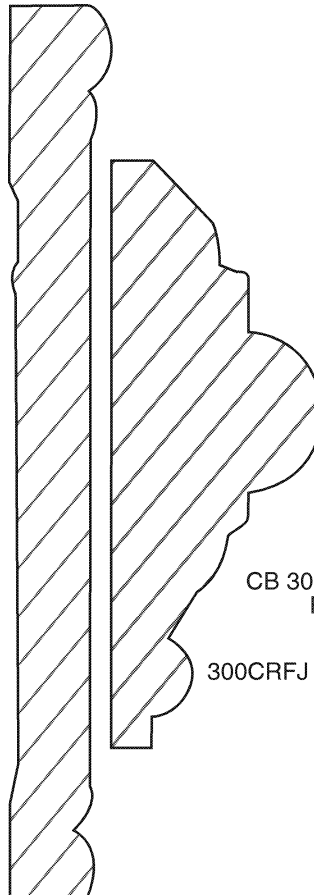

CB 300 1 1/16" X 3"  
FJ PINE

300CRFJ

# CORNERS, SHOE MOLDS, STOPS AND COVES

CB 205 1 1/8" X 1 1/8"  
CORNER MOULD  
A GRADE PINE

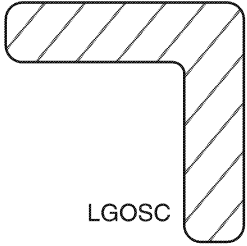

LGOSC

## OUTSIDE CORNERS

CB 206 11/16" X 11/16"  
CORNER MOULD  
A GRADE PINE

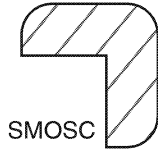

SMOSC

CB 106 11/16" X 11/16"  
QUARTER ROUND  
A GRADE PINE  
OAK

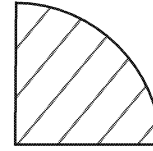

QTRRD

CB 129 7/16" X 11/16"  
SHOE MOULD  
A GRADE PINE  
OAK



SHOE  
OAKSHOE  
SHOEP

## SHOE MOULDINGS

CB 937 7/16" X 1 1/4"  
A GRADE PINE

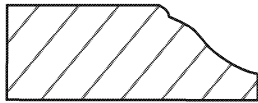

114STOP

CB 935 7/16" X 1 5/8"  
A GRADE PINE

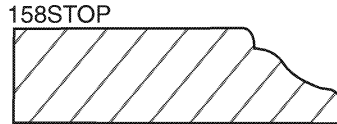

158STOP

## STOPS

CB 941 7/16" X 3/4"  
A GRADE PINE

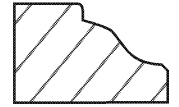

34STOP

CB 142 1/4" X 3/4"  
A GRADE PINE

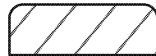

SCREEN

## SCREEN MOULD

CB 100 11/16" X 11/16"  
A GRADE PINE

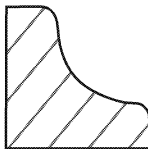

COVE

## COVE MOULD

CB 995 3/4" X 3/4"



CHAMFER

## CHAMFER STRIP

118STOP

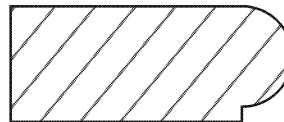

CB 118 1/2" X 1 1/2"

CB 266 1/4" X 1 1/2"  
A GRADE PINE

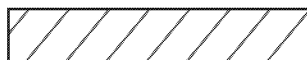

LATTICE

## LATTICE

CB 105 3/4" X 3/4"  
A GRADE OAK

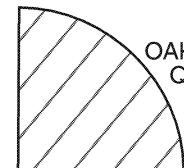

OAKQTRRD  
QTRRD

## QUARTER ROUND

# BASE CAP, MULL CASINGS, PICTURE AND JOINT MOULDS

CB 273 11/16" X 1 3/4"  
 PICTURE MOULD  
 FJ PINE  
 A GRADE PINE

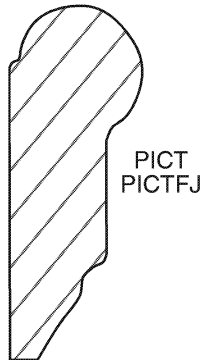

PICT  
 PICTFJ

PICTURE MOULD

CB 163 3/4" X 1 1/2"  
 BASE CAP  
 FJ PINE  
 A GRADE PINE

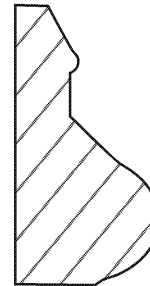

163CAP  
 163CAPFJ  
 163PVC

BASE CAP

CB 22 3/4" X 1 1/2"  
 CB3 MULL  
 A GRADE PINE

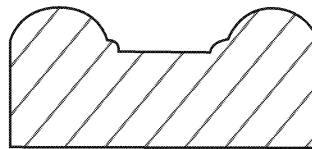

CB3MULL

MULL CASINGS

CB 988 3/8" X 1 3/8"  
 MULL  
 A GRADE PINE

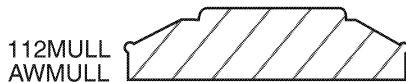

112MULL  
 AWMULL

CB 988 3/8" X 2"  
 MULL  
 A GRADE PINE



2MULL

CB 37 3/8" X 3/4"  
 A GRADE PINE



SMJOINT

CB 137 9/16" X 1 1/4"  
 FJ PINE

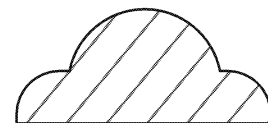

JOINTFJ

JOINT MOULDS

# NOSINGS, HANDRAIL, AND CLOSET ROD

CB 24 1" X 1 1/4"  
RETURN NOSING  
OAK

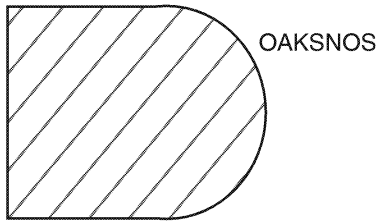

RETURN NOSING

CB 233 1 1/4"  
A GRADE PINE

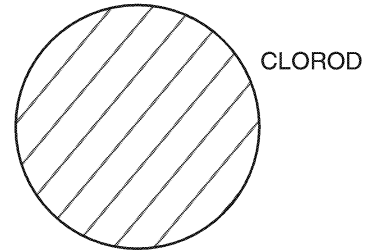

CLOSET ROD

CB 23 1" X 3 1/2"  
LANDING  
OAK

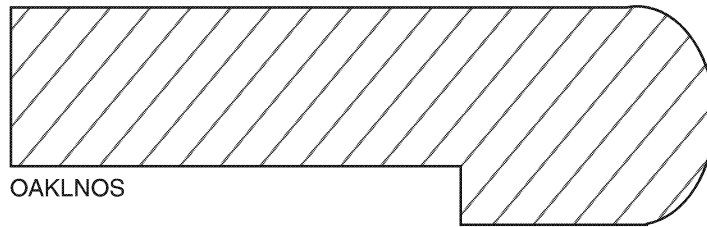

LANDING NOSING

CB 23A 1" X 5 1/4"  
LANDING  
OAK

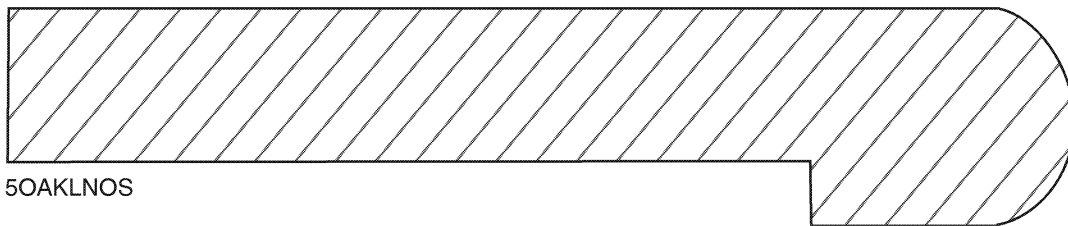

LANDING NOSING

CB 240 1 1/4" X 2 1/4"  
A GRADE PINE  
FJ PINE

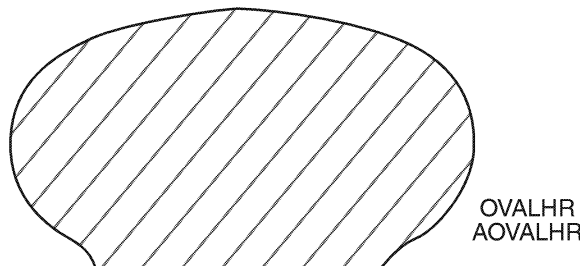

OVAL HANDRAIL

# EXTENSION JAMB, WINDOW SUBSILL, SILLS AND STOOLS

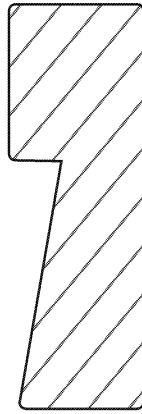

2XJAMB

5/8" X 2"

WINDOW EXTENSION JAMB

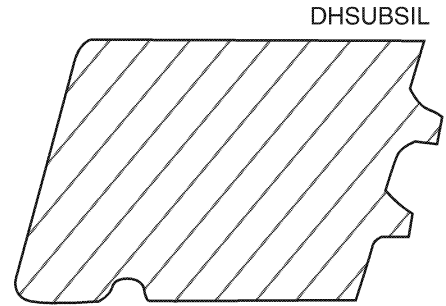

DHSUBSIL

1 3/8" X 2 1/8"

WINDOW SUBSILL

CB 1077 1 1/8" X 3 3/8"  
WINDOW STOOL  
A GRADE PINE

WIDESTL

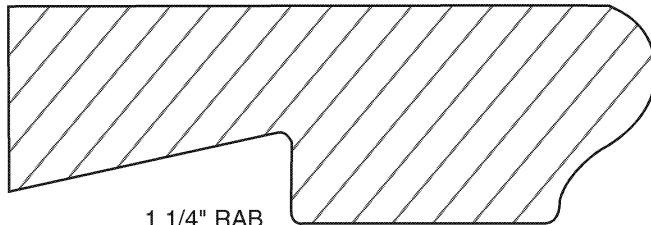

1 1/4" RAB

CB 1195 3/4" X 2 3/8"  
WINDOW STOOL  
FJ PINE  
A GRADE PINE

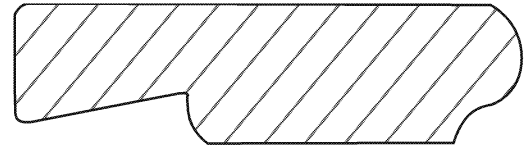

3/4" RAB

78STOOL  
STOOLFS

CB 26 5/8" X 4 5/8"  
WINDOW STOOL  
FJ PINE  
A GRADE PINE

45STOOL

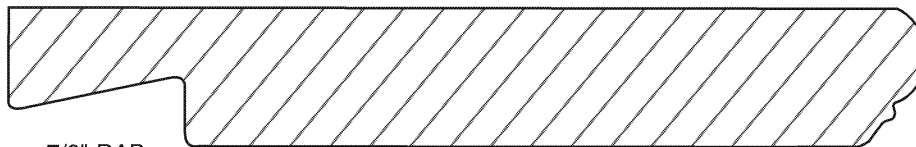

7/8" RAB

WINDOW STOOLS

AWSSIL

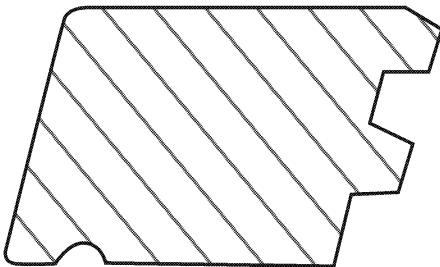

1" x 1 1/2"

ALL WEATHER SUBSILL

COMPSILL

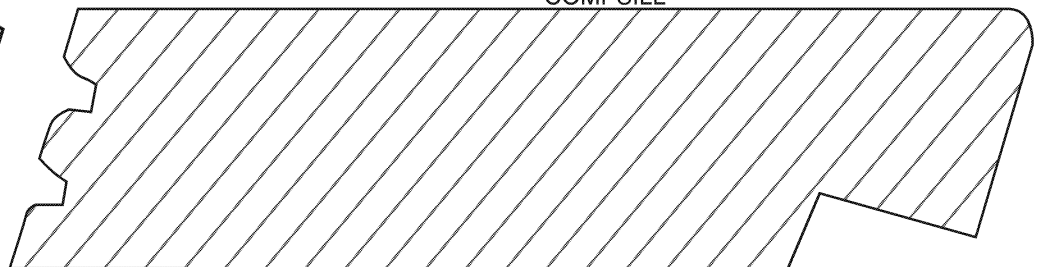

1 3/8" X 5 1/4"

WINDOW SILL COMPOSITE

# DRIP CAPS, T-ASTRAGALS, BRICK AND RAKE MOULDS

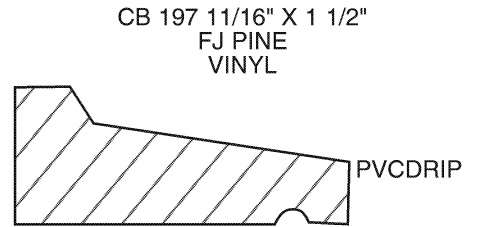
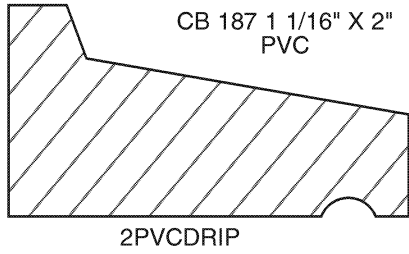

## DRIP CAPS

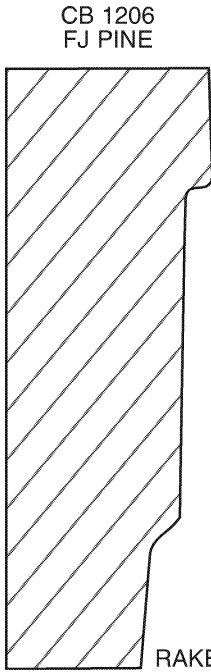

## RAKE MOULD

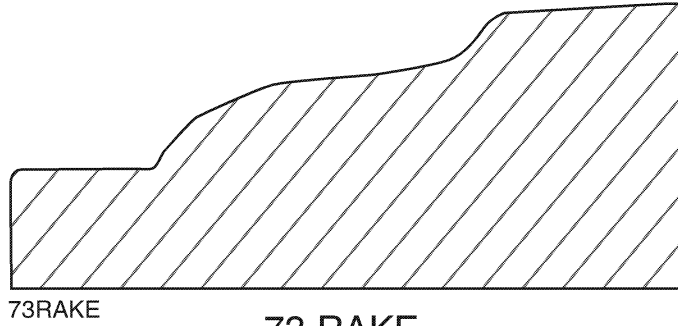

## 73 RAKE

1 1/2 X 3 1/2"  
#73 F/J RAKE MLD.

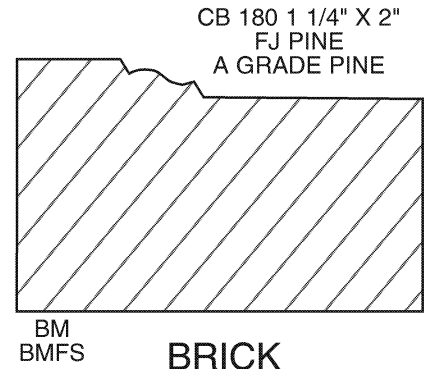

## BRICK MOULD

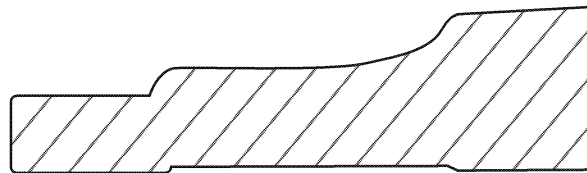

## 28 RAKE

13/16 X 3" #28 RAKE  
PVC

## AW 14BB ALL WEATHER COMBO

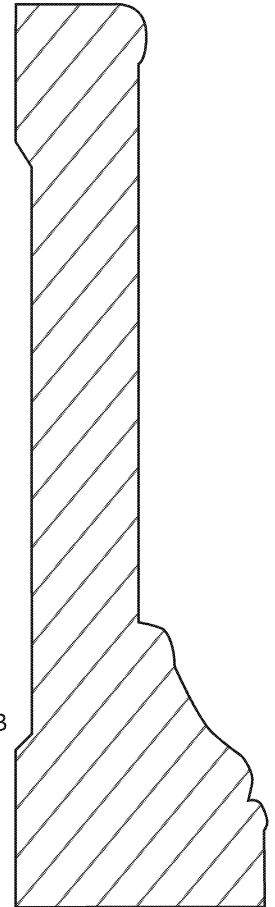

## 1X4 WITH BACK BAND COMBO

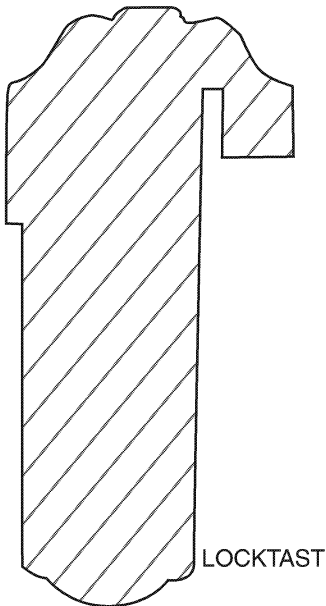

## LOCKTAST

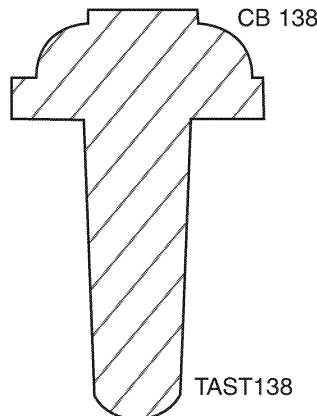

## T-ASTRAGALS

# MATEL AND PANEL MOULDS

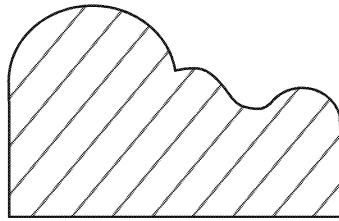

CB 42 1 1/16" X 1 5/8"  
FJ PINE  
A GRADE PINE

CB42  
CB42FJ

## PANEL MOULDINGS

CB 43R 1 7/8"  
FJ PINE  
A GRADE PINE

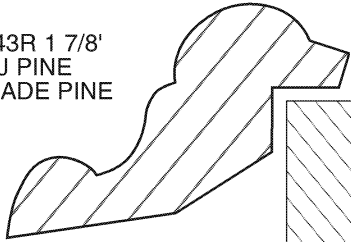

CB43RFJ

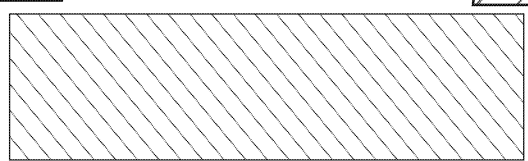

CB 42R 1 1/16" X 1 5/8"  
FJ PINE  
A GRADE PINE

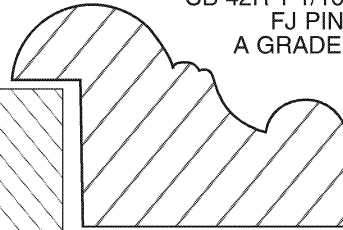

CB42R  
CB42FJ

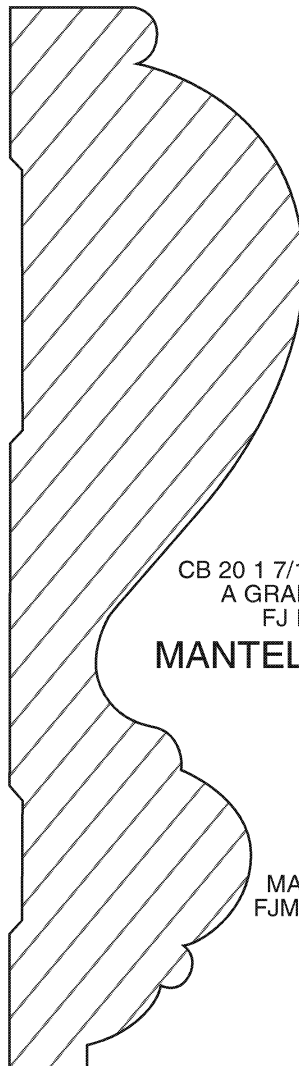

CB 20 1 7/16" X 5 7/16"  
A GRADE PINE  
FJ PINE

## MANTEL MOULD

MANMLD  
FJMANMLD



# PLINTH BLOCKS

CB 27 1 1/4" X 3 3/4"  
PLINTH MATERIAL  
FJ PINE

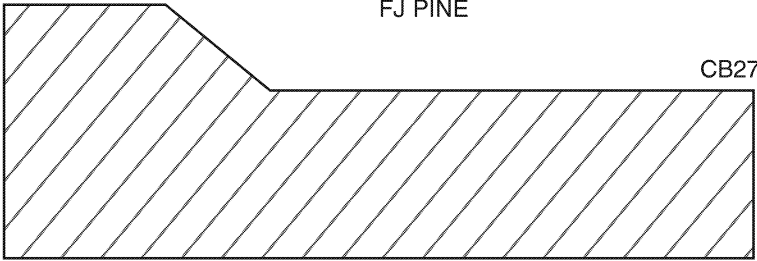

CB 3 SP3 1" X 5"  
PLINTH MATERIAL  
POPLAR

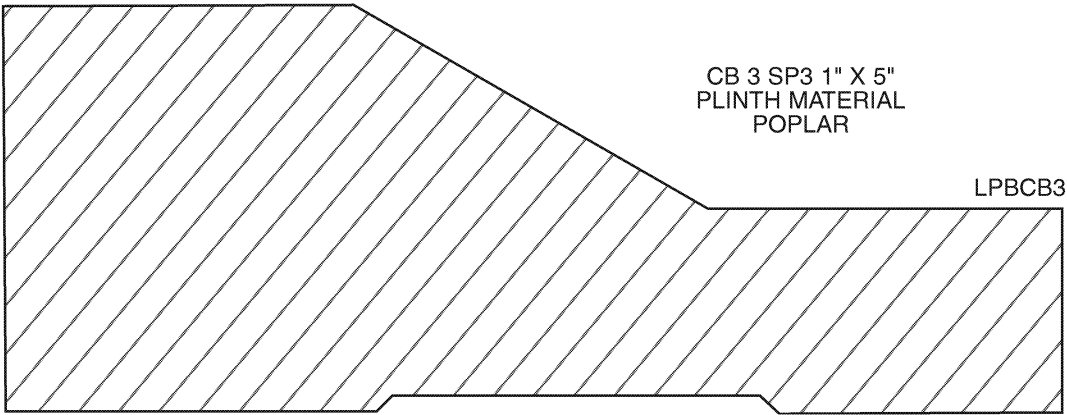

CB 306 8" X 4" X 1 1/8"  
PLINTH MATERIAL  
FJ PINE

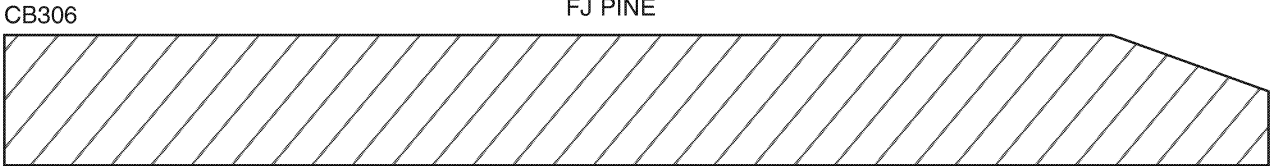

**NOT TO SCALE**

CB 408 12" X 8" X 1 3/8"  
PLINTH MATERIAL  
A GRADE PINE

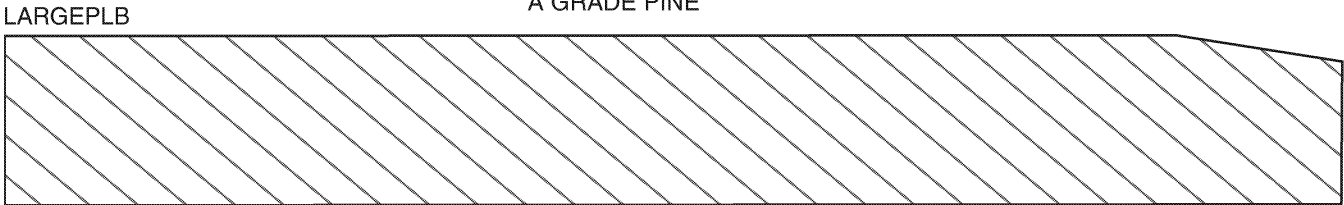

**NOT TO SCALE**

# DOOR SILL, DOUBLE RABBIT AND EXTERIOR DOOR JAMBS

DOUBLE RABBIT JAMB 3/4" X 4 5/8"  
FJ PINE

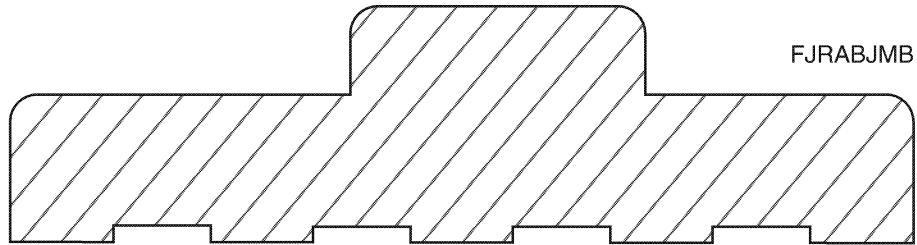

DOUBLE RABBIT  
JAMB

EXTERIOR DOOR JAMB 1 5/16" X 4 5/8"  
FJ PINE

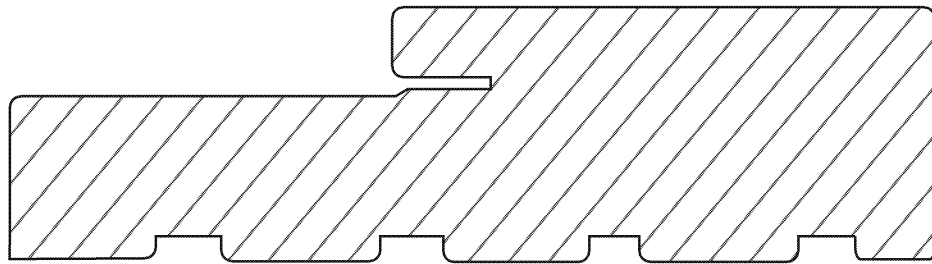

68FJX  
68FJXL  
68FJXR

EXTERIOR DOOR  
JAMB

EXTERIOR DOOR SILL 1 1/16" X 6 1/4"  
OAK

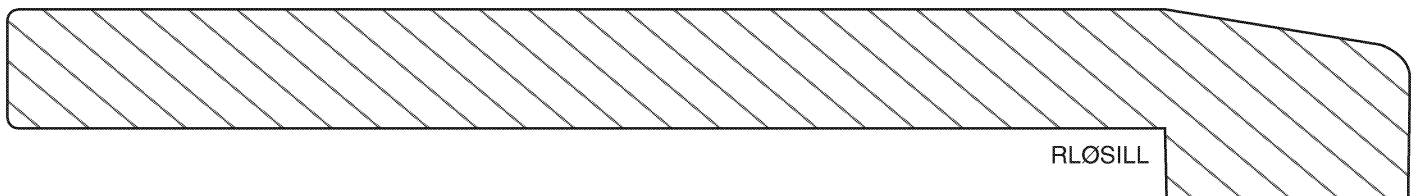

RLØSILL

EXTERIOR DOOR SILL

# WINDOW PARTS

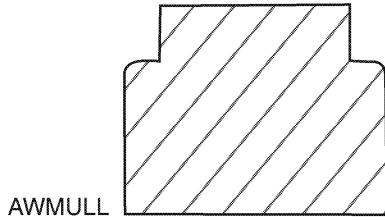

AWMULL

1 1/4" x 1 3/8"  
PVC

ALL WEATHER MULL - WINDOW

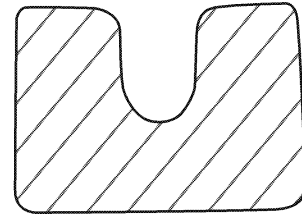

1 1/8" x 1 1/2"  
PVC

ALL WEATHER DOOR MULL

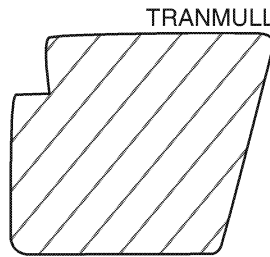

TRANMULL

1 1/8" x 1 1/4"  
PVC

TRANSOM MULL

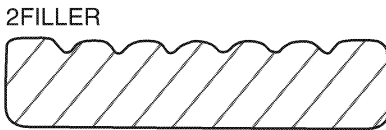

2FILLER

1/2" x 2"  
PVC

2 FILLER



28PARTBD  
30PARTBD  
34PARTBD

1/2" x 5/8"  
ALL WOOD PINE

DH PARTING BEAD

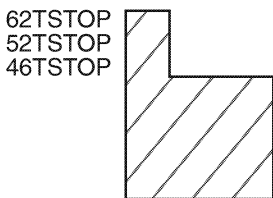

62TSTOP  
52TSTOP  
46TSTOP

11/16" x 1/2"  
ALL WOOD PINE

DH TILT STOP

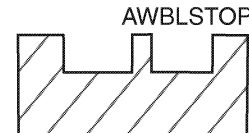

AWBLSTOP

1/2" x 1 1/4"  
PVC

ALL WEATHER BLIND STOP

