



A WHOLE NEW POINT OF VIEW.

TABLE OF CONTENTS

Technical Drawings 3

Double Hung Size Elevations & Light Patterns 4

Casement Size Elevations & Light Patterns 32

Awning Size Elevations & Light Patterns 62

Patio Door Size Elevations & Light Patterns 68

It's more than a window. It's a whole new point of view. At Ply Gem Windows, we have a different view for the way the window business should be run. We believe you should have access to all of the top quality styles and brands across the country. That's why we've taken our entire portfolio of brands, brands that you know and trust, and given them one name – Ply Gem Windows. With this one name comes a lot of big advantages, starting with a national manufacturing and distribution network. Pair that with our commitment to customer service, sustainable practices and wide variety of window styles that fit all of your design needs, and you'll get the right window for every project and every budget.

And, because we're part of the Ply Gem family, you know you'll always have access to leading brands. Windows, doors, siding and accessories, stone veneer, fence and rail, rainware, shutters and designer accents, we have something for every project. We work with residential builders, remodelers, architects, distributors and dealers to help build sales. When you combine over 50 years of experience, industry-leading customer service, and trusted local relationships you've got a company you can count on. **Ply Gem. Building products. Building success.**



Brick Siding

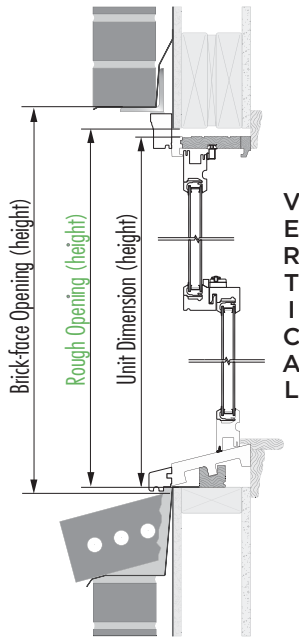
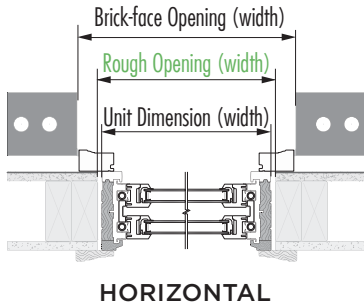

Vinyl Siding

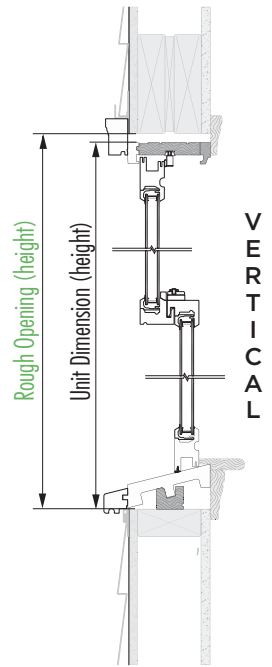
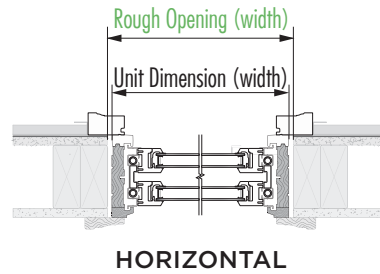

Wood Siding

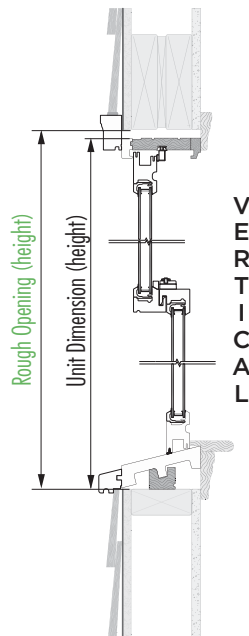
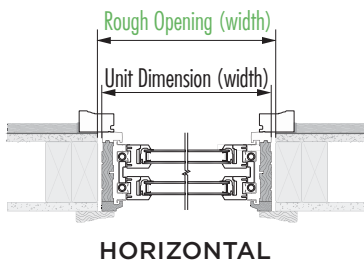

Heights

Unit Dimension Rough Opening Call Size	Widths						
	1'-9 3/8"	2'-1 3/8"	2'-5 3/8"	2'-9 3/8"	3'-1 3/8"	3'-5 3/8"	3'-9 3/8"
	1'-10 1/2"	2'-2 1/2"	2'-6 1/2"	2'-10 1/2"	3'-2 1/2"	3'-6 1/2"	3'-10 1/2"
	1-8	2-0	2-4	2-8	3-0	3-4	3-8 ‡
3'-1"	DH18210	DH20210	DH24210	DH28210	DH30210	DH34210	DH38210
3'-5"	DH1832	DH2032	DH2432	DH2832	DH3032	DH3432	DH3832
4'-1"	DH18310	DH20310	DH24310	DH28310	DH30310	DH34310	DH38310
4'-5"	DH1842	DH2042	DH2442	DH2842	DH3042	DH3442	DH3842
4'-9"	DH1846	DH2046	DH2446	DH2846	DH3046*	DH3446*	DH3846
5'-5"	DH1852	DH2052	DH2452	DH2852	DH3052	DH3452	DH3852
5'-9"	DH1856E	DH2056E	DH2456E	DH2856E	DH3056E	DH3456E	
5'-9"	DH1856C	DH2056C	DH2456C	DH2856C	DH3056C*	DH3456C*	
6'-5"	DH1862	DH2062	DH2462	DH2862	DH3062	DH3462	

NOTE:
 Shaded units satisfy IRC egress requirements. Units marked with an * indicate sizes in MW Pro 400 Series that DO NOT satisfy egress. Check with your local code official to confirm egress requirements in your area.

‡ NOTE: 3-8 Widths Not Available in MW Pro 400 Series











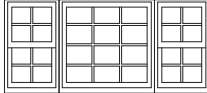
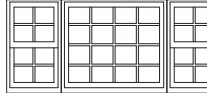
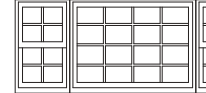
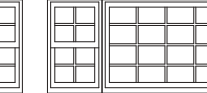
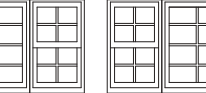
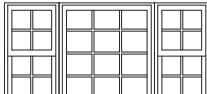
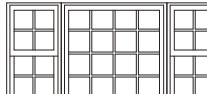
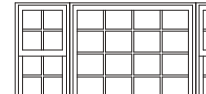
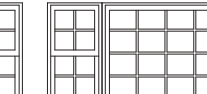
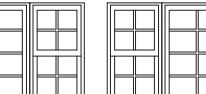
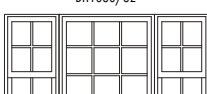
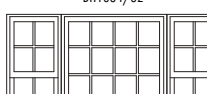

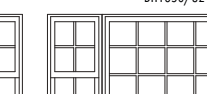







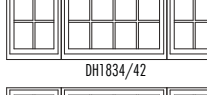



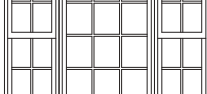
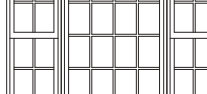

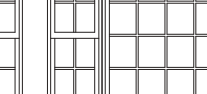
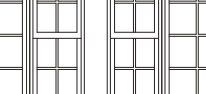
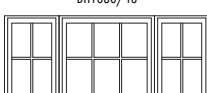
		Widths							
		3'-6 3/4"	4'-2 3/4"	4'-10 3/4"	5'-6 3/4"	6'-2 3/4"	6'-10 3/4"	7'-6 3/4"	
		3'-7 1/8"	4'-3 7/8"	4'-11 7/8"	5'-7 7/8"	6'-3 7/8"	6'-11 7/8"	7'-7 7/8"	
		1-8 Twin	2-0 Twin	2-4 Twin	2-8 Twin	3-0 Twin	3-4 Twin	3-8 Twin ‡	
Unit Dimension	Rough Opening	Call Size							
		3-1"	3-5"	4-1"	4-5"	4-9"	5'-5"	5'-9"	5'-9"
3-1"	3-1 5/8"	DH18210-2	DH20210-2	DH24210-2	DH28210-2	DH30210-2	DH34210-2	DH38210-2	
3-5"	3-5 5/8"	DH1832-2	DH2032-2	DH2432-2	DH2832-2	DH3032-2	DH3432-2	DH3832-2	
4-1"	4-1 5/8"	DH18310-2	DH20310-2	DH24310-2	DH28310-2	DH30310-2	DH34310-2	DH38310-2	
4-5"	4-5 5/8"	DH1842-2	DH2042-2	DH2442-2	DH2842-2	DH3042-2	DH3442-2	DH3842-2	
4-9"	4-9 5/8"	DH1846-2	DH2046-2	DH2446-2	DH2846-2	DH3046-2 *	DH3446-2 *	DH3846-2	
5'-5"	5'-5 5/8"	DH1852-2	DH2052-2	DH2452-2	DH2852-2	DH3052-2	DH3452-2	DH3852-2	
5'-9"	5'-9 5/8"	DH1856E-2	DH2056E-2	DH2456E-2	DH2856E-2	DH3056E-2	DH3456E-2		
5'-9"	5'-9 5/8"	DH1856C-2	DH2056C-2	DH2456C-2	DH2856C-2	DH3056C-2 *	DH3456C-2 *		
6-5"	6-5 5/8"	DH1862-2	DH2062-2	DH2462-2	DH2862-2	DH3062-2	DH3462-2		

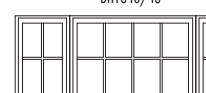
NOTE:
 Shaded units satisfy IRC egress requirements. **Units marked with an *** indicate sizes in MW Pro 400 Series that **DO NOT** satisfy egress. Check with your local code official to confirm egress requirements in your area.

WHEN ORDERING ADD ONE OF THE FOLLOWING PREFIXES TO SPECIFY YOUR SELECTED PRODUCT: J40 = MW Pro 400 UL = MW Pro 300 WD = MW Pro 200

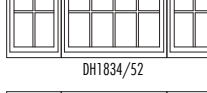
‡ NOTE: 3-8 Widths Not Available in MW Pro 400 Series

Widths

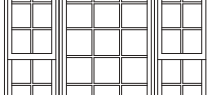
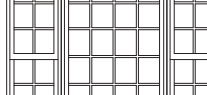
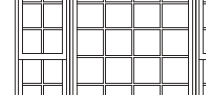
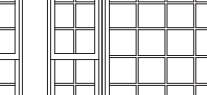
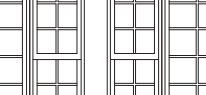

















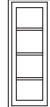







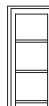



































Unit Dimension Rough Opening Call Size	6' - 8 1/8"	7' - 0 1/8"	7' - 8 1/8"	8' - 8 1/8"	9' - 8 1/8"
	6' - 9 1/4"	7' - 1 1/4"	7' - 9 1/4"	8' - 9 1/4"	9' - 9 1/4"
	18/30	18/34	18/40	18/50	18/60
3 - 1"	 DH1830/210	 DH1834/210	 DH1840/210	 DH1850/210	 DH1860/210
3 - 5"	 DH1830/32	 DH1834/32	 DH1840/32	 DH1850/32	 DH1860/32
4 - 1"	 DH1830/310	 DH1834/310	 DH1840/310	 DH1850/310	 DH1860/310
4 - 5"	 DH1830/42	 DH1834/42	 DH1840/42	 DH1850/42	 DH1860/42
4 - 9"	 DH1830/46	 DH1834/46	 DH1840/46	 DH1850/46	 DH1860/46
5 - 5"	 DH1830/52	 DH1834/52	 DH1840/52	 DH1850/52	 DH1860/52
5 - 9"	 DH1830/56E	 DH1834/56E	 DH1840/56E	 DH1850/56E	 DH1860/56E
5 - 9"	 DH1830/56C	 DH1834/56C	 DH1840/56C	 DH1850/56C	 DH1860/56C
6 - 5"	 DH1830/62	 DH1834/62	 DH1840/62	 DH1850/62	 DH1860/62

		Widths			
		7' - 4 1/8"	7' - 8 1/8"	8' - 4 1/8"	9' - 4 1/8"
		7' - 5 1/4"	7' - 9 1/4"	8' - 5 1/4"	9' - 5 1/4"
		20/30	20/34	20/40	20/50
Heights	Unit Dimension	3 - 1"	3 - 1"	3 - 1"	3 - 1"
	Rough Opening	3 - 1 5/8"	3 - 1 5/8"	3 - 1 5/8"	3 - 1 5/8"
	Call Size	2 - 10	2 - 10	2 - 10	2 - 10
		DH2030/210	DH2034/210	DH2040/210	DH2050/210
		DH2030/32	DH2034/32	DH2040/32	DH2050/32
		DH2030/310	DH2034/310	DH2040/310	DH2050/310
		DH2030/42	DH2034/42	DH2040/42	DH2050/42
		DH2030/46	DH2034/46	DH2040/46	DH2050/46
		DH2030/52	DH2034/52	DH2040/52	DH2050/52
		DH2030/56E	DH2034/56E	DH2040/56E	DH2050/56E
	DH2030/56C	DH2034/56C	DH2040/56C	DH2050/56C	
	DH2030/62	DH2034/62	DH2040/62	DH2050/62	
	3 - 5"	3 - 5"	3 - 5"	3 - 5"	
	3 - 5 5/8"	3 - 5 5/8"	3 - 5 5/8"	3 - 5 5/8"	
	3 - 2	3 - 2	3 - 2	3 - 2	
	4 - 1"	4 - 1"	4 - 1"	4 - 1"	
	4 - 1 5/8"	4 - 1 5/8"	4 - 1 5/8"	4 - 1 5/8"	
	3 - 10	3 - 10	3 - 10	3 - 10	
	4 - 5"	4 - 5"	4 - 5"	4 - 5"	
	4 - 5 5/8"	4 - 5 5/8"	4 - 5 5/8"	4 - 5 5/8"	
	4 - 2	4 - 2	4 - 2	4 - 2	
	4 - 9"	4 - 9"	4 - 9"	4 - 9"	
	4 - 9 5/8"	4 - 9 5/8"	4 - 9 5/8"	4 - 9 5/8"	
	4 - 6	4 - 6	4 - 6	4 - 6	
	5' - 5"	5' - 5"	5' - 5"	5' - 5"	
	5' - 5 5/8"	5' - 5 5/8"	5' - 5 5/8"	5' - 5 5/8"	
	5 - 2	5 - 2	5 - 2	5 - 2	
	5' - 9"	5' - 9"	5' - 9"	5' - 9"	
	5' - 9 5/8"	5' - 9 5/8"	5' - 9 5/8"	5' - 9 5/8"	
	5 - 6E	5 - 6E	5 - 6E	5 - 6E	
	5' - 9"	5' - 9"	5' - 9"	5' - 9"	
	5' - 9 5/8"	5' - 9 5/8"	5' - 9 5/8"	5' - 9 5/8"	
	5 - 6C	5 - 6C	5 - 6C	5 - 6C	
	6' - 5"	6' - 5"	6' - 5"	6' - 5"	
	6' - 5 5/8"	6' - 5 5/8"	6' - 5 5/8"	6' - 5 5/8"	
	6 - 2	6 - 2	6 - 2	6 - 2	

WHEN ORDERING ADD ONE OF THE FOLLOWING PREFIXES TO SPECIFY YOUR SELECTED PRODUCT: J40 = MW Pro 400 UL = MW Pro 300 WD = MW Pro 200

Heights











Widths

Unit Dimension Rough Opening Call Size	1'-1 3/8"	1'-3 3/8"	1'-5 3/8"	1'-9 3/8"	2'-1 3/8"	2'-5 3/8"	2'-9 3/8"
	1'-2 1/2"	1'-4 1/2"	1'-6 1/2"	1'-10 1/2"	2'-2 1/2"	2'-6 1/2"	2'-10 1/2"
	1-0	1-2	1-4	1-8	2-0	2-4	2-8
3-1"							
3-5"							
4-1"							
4-5"							
4-9"							
5-5"							
5-9"							
5-9"							
6-5"							



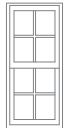
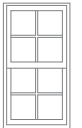
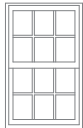



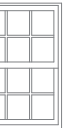

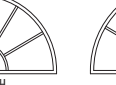

		Widths				
		3' - 1 3/8"	3' - 5 3/8"	4' - 1 3/8"	5' - 1 3/8"	6' - 1 3/8"
		3' - 2 1/2"	3' - 6 1/2"	4' - 2 1/2"	5' - 2 1/2"	6' - 2 1/2"
		3-0	3-4	4-0	5-0	6-0
Heights	Unit Dimension					
	Rough Opening					
	Call Size					
	3-1"					
	3-5"					
	4-1"					
	4-5"					
	4-9"					
	5-5"					
	5-9"					
	5-9"					
6-5"						

WHEN ORDERING ADD ONE OF THE FOLLOWING PREFIXES TO SPECIFY YOUR SELECTED PRODUCT: J40 = MW Pro 400 UL = MW Pro 300 WD = MW Pro 200



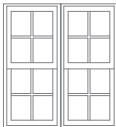
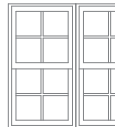
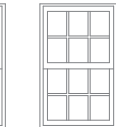
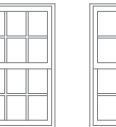

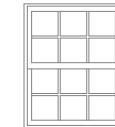
Single Widths

Heights	Single Widths							
	Unit Dimension	1' - 9 3/8"	2' - 1 3/8"	2' - 5 3/8"	2' - 9 3/8"	3' - 1 3/8"	3' - 5 3/8"	3' - 9 3/8"
	Rough Opening	1' - 10 1/2"	2' - 2 1/2"	2' - 6 1/2"	2' - 10 1/2"	3' - 2 1/2"	3' - 6 1/2"	3' - 10 1/2"
Call Size	1-8	2-0	2-4	2-8	3-0	3-4	3-8	
								
	DH18CH 0' - 11 15/16" 1' - 0 7/16"	DH20CH 1' - 1 15/16" 1' - 2 7/16"	DH24CH 1' - 3 15/16" 1' - 4 7/16"	DH28CH 1' - 5 15/16" 1' - 6 7/16"	DH30CH 1' - 7 15/16" 1' - 8 7/16"	DH34CH 1' - 9 15/16" 1' - 10 7/16"	DH38CH 1' - 11 15/16" 2' - 0 7/16"	
Grille Options (See chart on opposite page)								
	CO1, CG2, COL	CO1, CG2, COL	CO3, CG3, COL	CO3, CG3, COL	CO3, CG3, COL	CO1, CO2 CO3, CO4, CO5, CO6, CO7, CG2, CG3, CG4, COL	CO1, CO2 CO3, CO4, CO5, CO6, CO7, CG2, CG3, CG4, COL	

Twin Widths

Heights	Twin Widths						
	Unit Dimension	3' - 6 3/4"	4' - 2 3/4"	4' - 10 3/4"	5' - 6 3/4"	6' - 2 3/4"	6' - 10 3/4"
	Rough Opening	3' - 7 7/8"	4' - 3 7/8"	4' - 11 7/8"	5' - 7 7/8"	6' - 3 7/8"	6' - 11 7/8"
Call Size	1-8 Twin	2-0 Twin	2-4 Twin	2-8 Twin	3-0 Twin	3-4 Twin	
							
	DH18-2CH 1' - 10 5/8" 1' - 11 1/8"	DH20-2CH 2' - 2 5/8" 2' - 3 1/8"	DH24-2CH 2' - 6 5/8" 2' - 7 1/8"	DH28-2CH 2' - 10 5/8" 2' - 11 1/8"	DH30-2CH 3' - 2 5/8" 3' - 3 1/8"	DH34-2CH 3' - 6 5/8" 3' - 7 1/8"	
Grille Options (See chart on opposite page)							
	CO1, CO2, CO3, CO4, CO5, CO6, CO7, CG2, CG4, COL	CO1, CO2, CO3, CO4, CO5, CO6, CO7, CG2, CG4, COL	CO1, CO2, CO3, CO4, CO5, CO6, CO7, CO8, CO9, C10, C11, C12, CG2, CG3, CG4, CG5, CG6, COL	CO1, CO2, CO3, CO4, CO5, CO6, CO7, CO8, CO9, C10, C11, C12, CG2, CG3, CG4, CG5, CG6, COL	CO1, CO2, CO3, CO4, CO5, CO6, CO7, CO8, CO9, C10, C11, C12, CG2, CG3, CG4, CG5, CG6, COL	CO1, CO2, CO3, CO4, CO5, CO6, CO7, CO8, CO9, C10, C11, C12, CG2, CG3, CG4, CG5, CG6, CG7, CG8, COL	

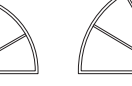
Picture Widths

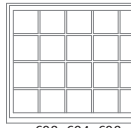
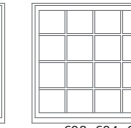
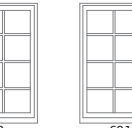
Heights	Picture Widths				
	Unit Dimension	4' - 1 3/8"	4' - 5 3/8"	5' - 1 3/8"	6' - 1 3/8"
	Rough Opening	4' - 2 1/2"	4' - 6 1/2"	5' - 2 1/2"	6' - 2 1/2"
Call Size	4-0 Picture	4-4 Picture	5-0 Picture	6-0 Picture	
					
	DH40PCH 2' - 1 15/16" 2' - 2 7/16"	DH44PCH 2' - 3 15/16" 2' - 4 7/16"	DH50PCH 2' - 7 15/16" 2' - 8 7/16"	DH60PCH 3' - 1 15/16" 3' - 2 7/16"	
Grille Options (See chart on opposite page)					
	CO1, CO2, CO3, CO4, CO5, CO6, CO7, CG2, CG3, COL	CO3, CO4, CO8, CO9, CG3, CG5, COL	CO3, CO4, CO8, CO9, CG3, CG5, COL	CO1, CO2, CO3, CO4, CO5, CO6, CO7, CO8, CO9, C10, C11, C12, CG2, CG3, CG4, CG6, COL	

Optional Grille Patterns

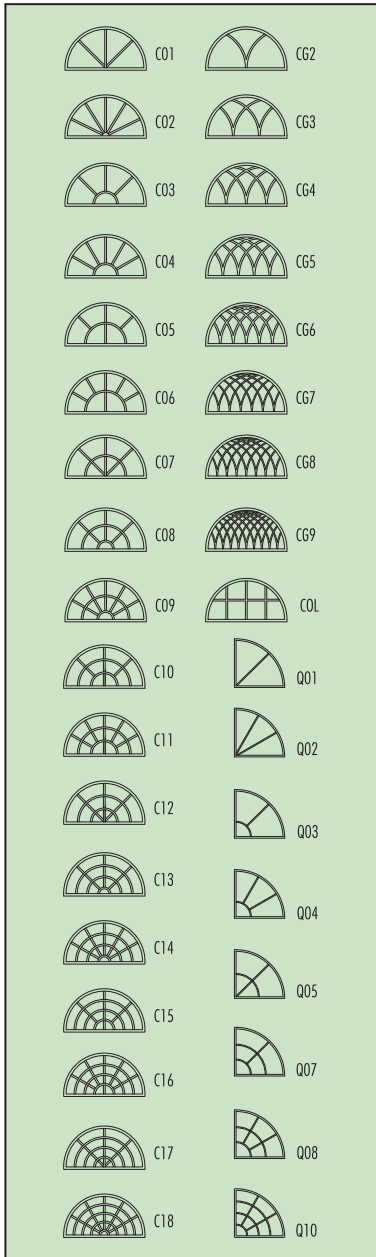

Use order code to specify pattern

Quarter Circle Widths

Heights	Quarter Circle Widths				
	Unit Dimension	2' - 1 3/8"	2' - 5 3/8"	2' - 9 3/8"	3' - 1 3/8"
	Rough Opening	2' - 2 1/2"	2' - 6 1/2"	2' - 10 1/2"	3' - 2 1/2"
	Call Size	2-0	2-4	2-8	3-0
		DH20QC 2' - 2 3/8" 2' - 3 1/8"	DH24QC 2' - 6 3/8" 2' - 7 1/8"	DH28QC 2' - 10 3/8" 2' - 11 1/8"	DH30QC 3' - 2 3/8" 3' - 3 1/8"
	Grille Options (See chart on this page)				
		Q01, Q02, Q03, Q04, Q05, COL	Q01, Q02, Q03, Q04, Q05, Q07, Q08, COL	Q01, Q02, Q03, Q04, Q05, Q07, Q08, COL	Q01, Q02, Q03, Q04, Q05, Q07, Q08, COL

Twin Widths

Heights	Twin Widths				
	Unit Dimension	4' - 2 3/4"	4' - 10 3/4"	5' - 6 3/4"	6' - 2 3/4"
	Rough Opening	4' - 3 7/8"	4' - 11 7/8"	5' - 7 7/8"	6' - 3 7/8"
	Call Size	2-0 Twin	2-4 Twin	2-8 Twin	3-0 Twin
		DH20-2EL 0' - 10 1/16" 0' - 11 1/16"	DH24-2EL 1' - 1 3/8" 1' - 1 7/8"	DH28-2EL 1' - 3 3/16" 1' - 3 11/16"	DH30-2EL 1' - 4 15/16" 1' - 5 7/16"
	Grille Options (See chart on this page)				
		C01, C02, C03, C04, C05, C06, C07, C02, C03, C04, COL	C01, C02, C03, C04, C05, C06, C07, C02, C03, C04, COL	C01, C02, C03, C04, C05, C06, C07, C02, C03, C04, C05, C06, COL	C01, C02, C03, C04, C05, C06, C07, C02, C03, C04, C05, C06, COL

Picture Widths

Heights	Picture Widths			
	Unit Dimension	4' - 1 3/8"	5' - 1 3/8"	6' - 1 3/8"
	Rough Opening	4' - 2 1/2"	5' - 2 1/2"	6' - 2 1/2"
	Call Size	4-0 Picture	5-0 Picture	6-0 Picture
		DH40-PEL 1' - 1 1/4" 1' - 0 3/4"	DH50-PEL 1' - 1 15/16" 1' - 2 1/16"	DH60-PEL 1' - 4 11/16" 1' - 5 3/16"
	Grille Options (See chart on this page)			
		C01, C02, C03, C04, COL	C03, C04, C03, C05, COL	C01, C02, C03, C04, C05, C06, C07, C02, C03, C04, C05, C06, C06, COL

WHEN ORDERING ADD ONE OF THE FOLLOWING PREFIXES TO SPECIFY YOUR SELECTED PRODUCT: J40 = MW Pro 400 UL = MW Pro 300 WD = MW Pro 200

Double Hung – True Radius Single Units

MW PRO SERIES 400, 300, 200

Standard Colonial Grille Pattern Widths

Heights

Unit height dimension is listed first under individual windows

Rough opening height dimension is listed second under individual windows

Unit Dimension	1' - 9 3/8"	2' - 1 3/8"	2' - 5 3/8"	2' - 9 3/8"	3' - 1 3/8"	3' - 5 3/8"	1' - 1 3/8"
Rough Opening	1' - 10 1/4"	2' - 2 1/2"	2' - 6 1/2"	2' - 10 1/4"	3' - 2 1/4"	3' - 6 1/4"	1' - 2 1/4"
Call Size	1-8	2-0	2-4	2-8	3-0	3-4	1-0
2-10	 DH18210TR 3' - 11 1/4" 3' - 11 3/8"	 DH20210TR 4' - 1 1/4" 4' - 1 7/8"	 DH24210TR 4' - 3 1/4" 4' - 3 7/8"	 DH28210TR 4' - 5 1/4" 4' - 5 7/8"	 DH30210TR 4' - 7 1/4" 4' - 7 7/8"	 DH34210TR 4' - 9 1/4" 4' - 9 7/8"	 DH10210SL
3-2	 DH1832TR 4' - 3 1/4" 4' - 3 7/8"	 DH2032TR 4' - 5 1/4" 4' - 5 7/8"	 DH2432TR 4' - 7 1/4" 4' - 7 7/8"	 DH2832TR 4' - 9 1/4" 4' - 9 7/8"	 DH3032TR 4' - 11 1/4" 4' - 11 7/8"	 DH3432TR 5' - 1 1/4" 5' - 1 7/8"	 DH1032SL
3-10	 DH18310TR 4' - 11 1/4" 4' - 11 7/8"	 DH20310TR 5' - 1 1/4" 5' - 1 7/8"	 DH24310TR 5' - 3 1/4" 5' - 3 7/8"	 DH28310TR 5' - 5 1/4" 5' - 5 7/8"	 DH30310TR 5' - 7 1/4" 5' - 7 7/8"	 DH34310TR 5' - 9 1/4" 5' - 9 7/8"	 DH10310SL
4-2	 DH1842TR 5' - 3 1/4" 5' - 3 7/8"	 DH2042TR 5' - 5 1/4" 5' - 5 7/8"	 DH2442TR 5' - 7 1/4" 5' - 7 7/8"	 DH2842TR 5' - 9 1/4" 5' - 9 7/8"	 DH3042TR 5' - 11 1/4" 5' - 11 7/8"	 DH3442TR 6' - 1 1/4" 6' - 1 7/8"	 DH1042SL
4-4	 DH1846TR 5' - 7 1/4" 5' - 7 7/8"	 DH2046TR 5' - 9 1/4" 5' - 9 7/8"	 DH2446TR 5' - 11 1/4" 5' - 11 7/8"	 DH2846TR 6' - 1 1/4" 6' - 1 7/8"	 DH3046TR 6' - 3 1/4" 6' - 3 7/8"	 DH3446TR 6' - 5 1/4" 6' - 5 7/8"	 DH1046SL
4-6	 DH1852TR 6' - 3 1/4" 6' - 3 7/8"	 DH2052TR 6' - 5 1/4" 6' - 5 7/8"	 DH2452TR 6' - 7 1/4" 6' - 7 7/8"	 DH2852TR 6' - 9 1/4" 6' - 9 7/8"	 DH3052TR 6' - 11 1/4" 6' - 11 7/8"	 DH3452TR 7' - 1 1/4" 7' - 1 7/8"	 DH1052SL
4-8	 DH1856TR 6' - 7 1/4" 6' - 7 7/8"	 DH2056TR 6' - 9 1/4" 6' - 9 7/8"	 DH2456TR 6' - 11 1/4" 6' - 11 7/8"	 DH2856TR 7' - 1 1/4" 7' - 1 7/8"	 DH3056TR 7' - 3 1/4" 7' - 3 7/8"	 DH3456TR 7' - 5 1/4" 7' - 5 7/8"	 DH1056SL
4-10	 DH1862TR 7' - 3 1/4" 7' - 3 7/8"	 DH2062TR 7' - 5 1/4" 7' - 5 7/8"	 DH2462TR 7' - 7 1/4" 7' - 7 7/8"	 DH2862TR 7' - 9 1/4" 7' - 9 7/8"	 DH3062TR 7' - 11 1/4" 7' - 11 7/8"	 DH3462TR 8' - 1 1/4" 8' - 1 7/8"	 DH1062SL

Optional Gothic Grille Pattern Widths

Unit Dimension Rough Opening Call Size	1' - 9 3/8"	2' - 1 3/8"	2' - 5 3/8"	2' - 9 3/8"	3' - 1 3/8"	3' - 5 3/8"	1' - 1 3/8"
	1' - 10 1/2"	2' - 2 1/2"	2' - 6 1/2"	2' - 10 1/2"	3' - 2 1/2"	3' - 6 1/2"	1' - 2 1/2"
	1-8	2-0	2-4	2-8	3-0	3-4	1-0
2-10	 DH1821OTR 3' - 11 1/4" 3' - 11 7/8"	 DH2021OTR 4' - 1 1/4" 4' - 1 7/8"	 DH2421OTR 4' - 3 1/4" 4' - 3 7/8"	 DH2821OTR 4' - 5 1/4" 4' - 5 7/8"	 DH3021OTR 4' - 7 1/4" 4' - 7 7/8"	 DH3421OTR 4' - 9 1/4" 4' - 9 7/8"	 DH1021OSL
3-2	 DH1832TR 4' - 3 1/4" 4' - 3 7/8"	 DH2032TR 4' - 5 1/4" 4' - 5 7/8"	 DH2432TR 4' - 7 1/4" 4' - 7 7/8"	 DH2832TR 4' - 9 1/4" 4' - 9 7/8"	 DH3032TR 4' - 11 1/4" 4' - 11 7/8"	 DH3432TR 5' - 1 1/4" 5' - 1 7/8"	 DH1032SL
3-10	 DH1831OTR 4' - 11 1/4" 4' - 11 7/8"	 DH2031OTR 5' - 1 1/4" 5' - 1 7/8"	 DH2431OTR 5' - 3 1/4" 5' - 3 7/8"	 DH2831OTR 5' - 5 1/4" 5' - 5 7/8"	 DH3031OTR 5' - 7 1/4" 5' - 7 7/8"	 DH3431OTR 5' - 9 1/4" 5' - 9 7/8"	 DH1031OSL
4-2	 DH1842TR 5' - 3 1/4" 5' - 3 7/8"	 DH2042TR 5' - 5 1/4" 5' - 5 7/8"	 DH2442TR 5' - 7 1/4" 5' - 7 7/8"	 DH2842TR 5' - 9 1/4" 5' - 9 7/8"	 DH3042TR 5' - 11 1/4" 5' - 11 7/8"	 DH3442TR 6' - 1 1/4" 6' - 1 7/8"	 DH1042SL
4-6	 DH1846TR 5' - 7 1/4" 5' - 7 7/8"	 DH2046TR 5' - 9 1/4" 5' - 9 7/8"	 DH2446TR 5' - 11 1/4" 5' - 11 7/8"	 DH2846TR 6' - 1 1/4" 6' - 1 7/8"	 DH3046TR 6' - 3 1/4" 6' - 3 7/8"	 DH3446TR 6' - 5 1/4" 6' - 5 7/8"	 DH1046SL
5-2	 DH1852TR 6' - 3 1/4" 6' - 3 7/8"	 DH2052TR 6' - 5 1/4" 6' - 5 7/8"	 DH2452TR 6' - 7 1/4" 6' - 7 7/8"	 DH2852TR 6' - 9 1/4" 6' - 9 7/8"	 DH3052TR 6' - 11 1/4" 6' - 11 7/8"	 DH3452TR 7' - 1 1/4" 7' - 1 7/8"	 DH1052SL
5-6	 DH1856TR 6' - 7 1/4" 6' - 7 7/8"	 DH2056TR 6' - 9 1/4" 6' - 9 7/8"	 DH2456TR 6' - 11 1/4" 6' - 11 7/8"	 DH2856TR 7' - 1 1/4" 7' - 1 7/8"	 DH3056TR 7' - 3 1/4" 7' - 3 7/8"	 DH3456TR 7' - 5 1/4" 7' - 5 7/8"	 DH1056SL
6-2	 DH1862TR 7' - 3 1/4" 7' - 3 7/8"	 DH2062TR 7' - 5 1/4" 7' - 5 7/8"	 DH2462TR 7' - 7 1/4" 7' - 7 7/8"	 DH2862TR 7' - 9 1/4" 7' - 9 7/8"	 DH3062TR 7' - 11 1/4" 7' - 11 7/8"	 DH3462TR 8' - 1 1/4" 8' - 1 7/8"	 DH1062SL

WHEN ORDERING ADD ONE OF THE FOLLOWING PREFIXES TO SPECIFY YOUR SELECTED PRODUCT: J40 = MW Pro 400 UL = MW Pro 300 WD = MW Pro 200

Standard Colonial Grille Pattern Widths

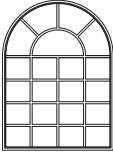
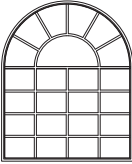
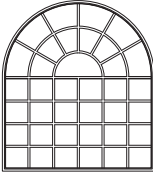
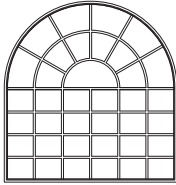
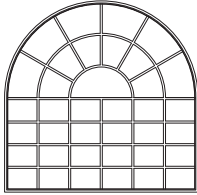
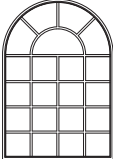
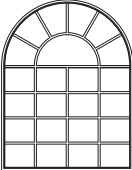
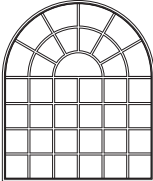
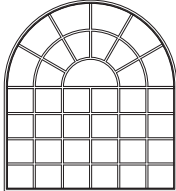
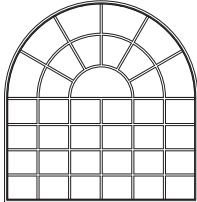
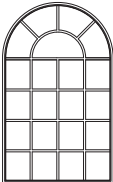
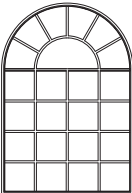
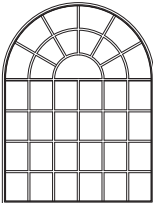
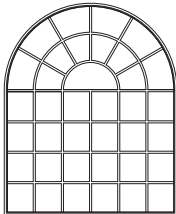
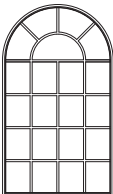
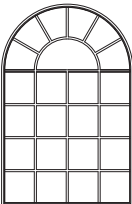
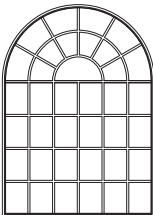
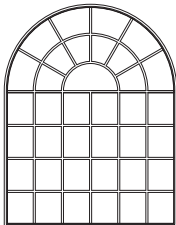
		3' - 6 ³ / ₄ "	4' - 2 ³ / ₄ "	4' - 10 ³ / ₄ "	5' - 6 ³ / ₄ "	6' - 2 ³ / ₄ "
		Rough Opening 3' - 7 ⁷ / ₈ "	Rough Opening 4' - 3 ⁷ / ₈ "	Rough Opening 4' - 11 ⁷ / ₈ "	Rough Opening 5' - 7 ⁷ / ₈ "	Rough Opening 6' - 3 ⁷ / ₈ "
		Call Size 1-8 Twin	Call Size 2-0 Twin	Call Size 2-4 Twin	Call Size 2-8 Twin	Call Size 3-0 Twin
Heights Unit height dimension is listed first under individual windows Rough Opening height dimension is listed second under individual windows	Unit Dimension 2-10	 DH18210-2TR 4' - 9 ¹⁵ / ₁₆ " 4' - 10 ³ / ₁₆ "	 DH20210-2TR 5' - 1 ¹⁵ / ₁₆ " 5' - 2 ³ / ₁₆ "	 DH24210-2TR 5' - 5 ¹⁵ / ₁₆ " 5' - 6 ³ / ₁₆ "	 DH28210-2TR 5' - 9 ¹⁵ / ₁₆ " 5' - 10 ³ / ₁₆ "	 DH30210-2TR 6' - 1 ¹⁵ / ₁₆ " 6' - 2 ³ / ₁₆ "
	Unit Dimension 3-2	 DH1832-2TR 5' - 1 ¹⁵ / ₁₆ " 5' - 2 ³ / ₁₆ "	 DH2032-2TR 5' - 5 ¹⁵ / ₁₆ " 5' - 6 ³ / ₁₆ "	 DH2432-2TR 5' - 9 ¹⁵ / ₁₆ " 5' - 10 ³ / ₁₆ "	 DH2832-2TR 6' - 1 ¹⁵ / ₁₆ " 6' - 2 ³ / ₁₆ "	 DH3032-2TR 6' - 5 ¹⁵ / ₁₆ " 6' - 6 ³ / ₁₆ "
	Unit Dimension 3-10	 DH18310-2TR 5' - 9 ¹⁵ / ₁₆ " 5' - 10 ³ / ₁₆ "	 DH20310-2TR 6' - 1 ¹⁵ / ₁₆ " 6' - 2 ³ / ₁₆ "	 DH24310-2TR 6' - 5 ¹⁵ / ₁₆ " 6' - 6 ³ / ₁₆ "	 DH28310-2TR 6' - 9 ¹⁵ / ₁₆ " 6' - 10 ³ / ₁₆ "	
	Unit Dimension 4-2	 DH1842-2TR 6' - 1 ¹⁵ / ₁₆ " 6' - 2 ³ / ₁₆ "	 DH2042-2TR 6' - 5 ¹⁵ / ₁₆ " 6' - 6 ³ / ₁₆ "	 DH2442-2TR 6' - 9 ¹⁵ / ₁₆ " 6' - 10 ³ / ₁₆ "	 DH2842-2TR 7' - 1 ¹⁵ / ₁₆ " 7' - 2 ³ / ₁₆ "	

Standard Colonial Grille Pattern Widths

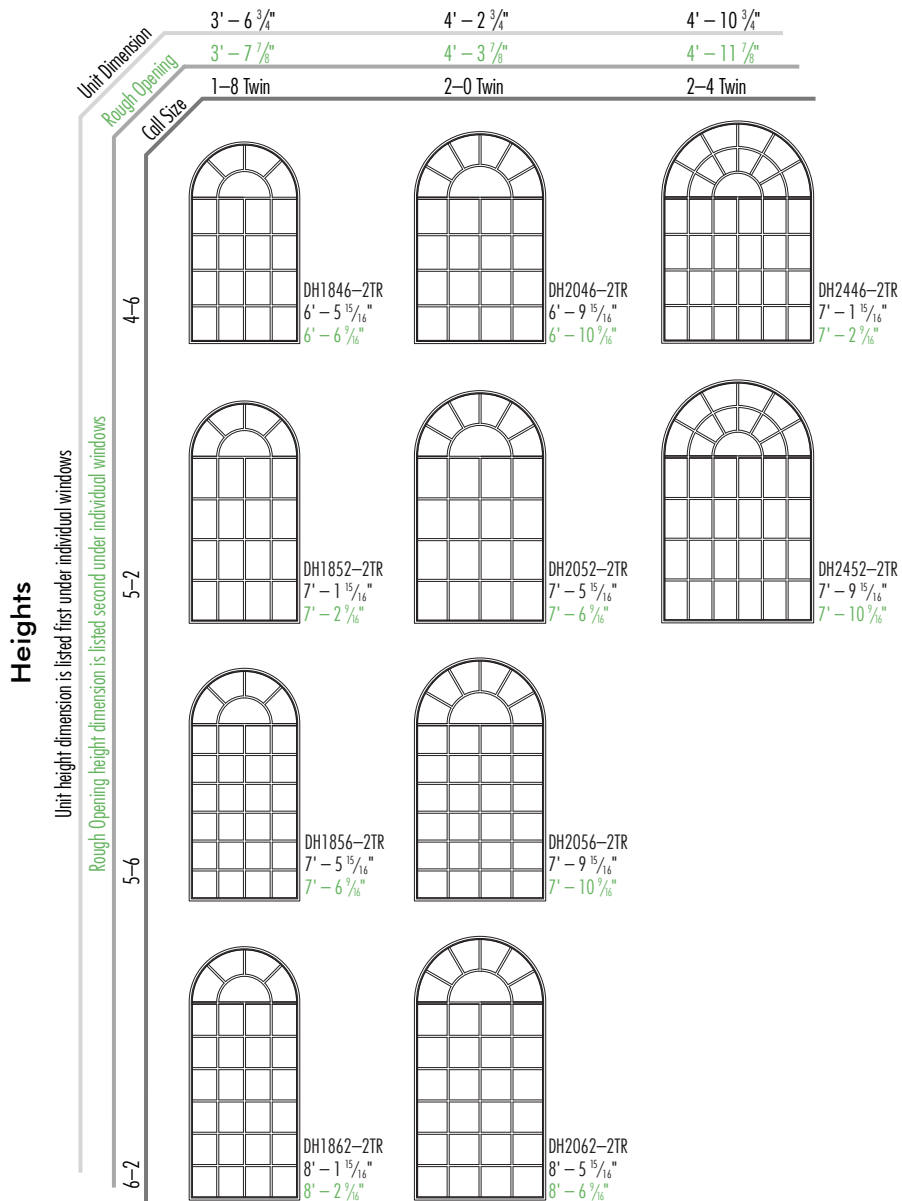

WHEN ORDERING ADD ONE OF THE FOLLOWING PREFIXES TO SPECIFY YOUR SELECTED PRODUCT: J40 = MW Pro 400 UL = MW Pro 300 WD = MW Pro 200

Optional Gothic Grille Pattern Widths

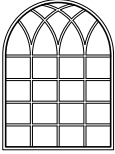
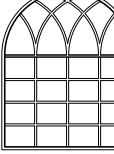
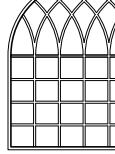
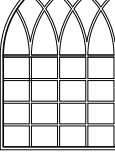
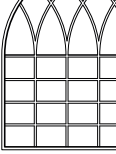
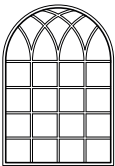
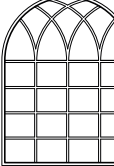
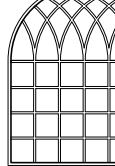
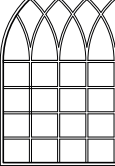
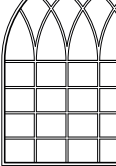
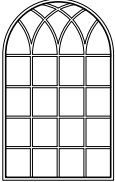
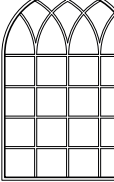
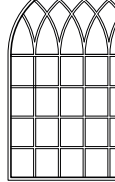
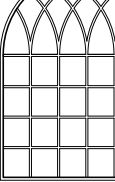
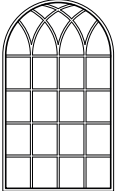
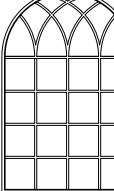
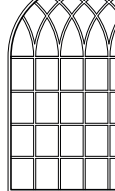
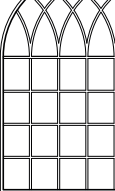



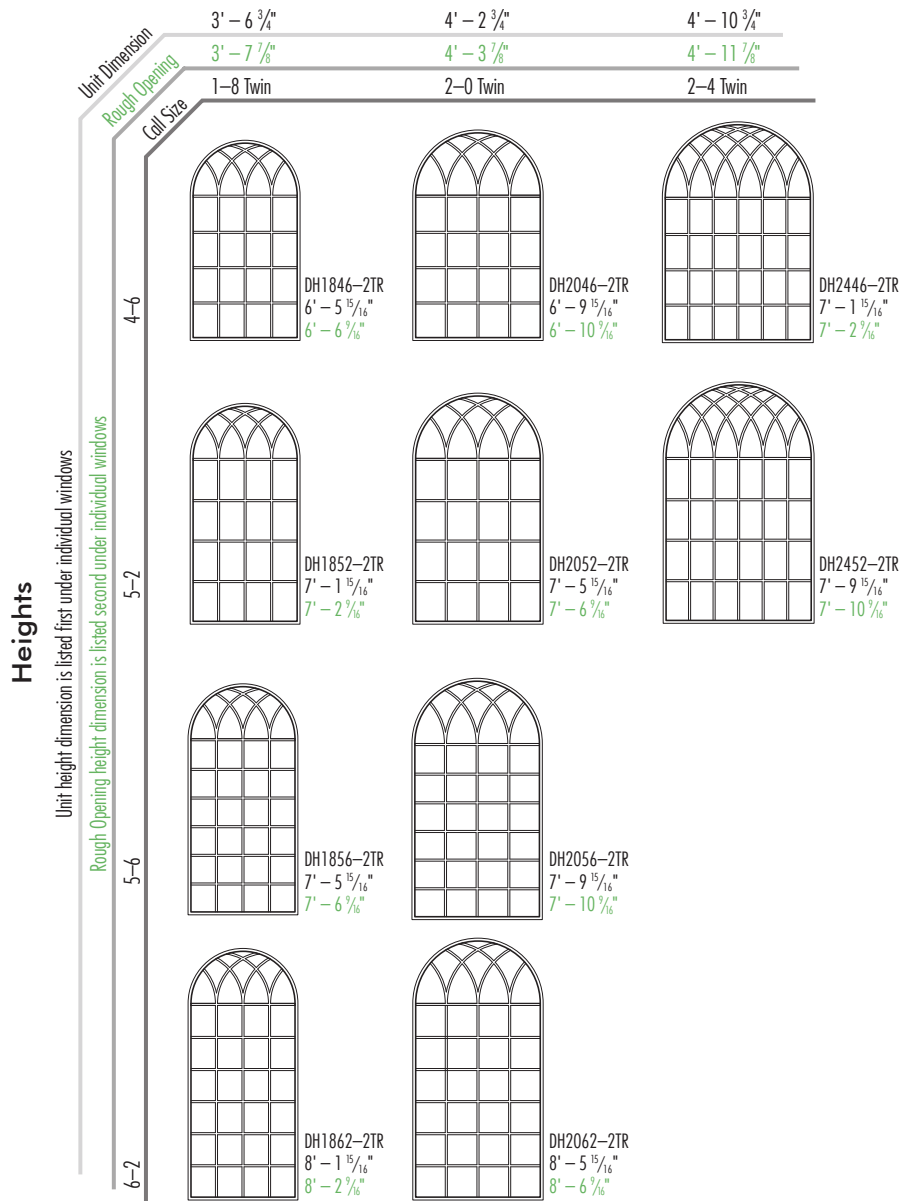

















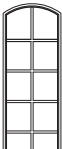













		3' – 6 ³ / ₄ "	4' – 2 ³ / ₄ "	4' – 10 ³ / ₄ "	5' – 6 ³ / ₄ "	6' – 2 ³ / ₄ "
		3' – 7 ⁷ / ₈ "	4' – 3 ⁷ / ₈ "	4' – 11 ⁷ / ₈ "	5' – 7 ⁷ / ₈ "	6' – 3 ⁷ / ₈ "
		1-8 Twin	2-0 Twin	2-4 Twin	2-8 Twin	3-0 Twin
Heights Unit height dimension is listed first under individual windows Rough Opening height dimension is listed second under individual windows Call Size	2-10	 DH18210-2TR 4' – 9 ¹⁵ / ₁₆ " 4' – 10 ³ / ₈ "	 DH20210-2TR 5' – 1 ¹⁵ / ₁₆ " 5' – 2 ³ / ₈ "	 DH24210-2TR 5' – 5 ¹⁵ / ₁₆ " 5' – 6 ³ / ₈ "	 DH28210-2TR 5' – 9 ¹⁵ / ₁₆ " 5' – 10 ³ / ₈ "	 DH30210-2TR 6' – 1 ¹⁵ / ₁₆ " 6' – 2 ³ / ₈ "
	3-2	 DH1832-2TR 5' – 1 ¹⁵ / ₁₆ " 5' – 2 ³ / ₈ "	 DH2032-2TR 5' – 5 ¹⁵ / ₁₆ " 5' – 6 ³ / ₈ "	 DH2432-2TR 5' – 9 ¹⁵ / ₁₆ " 5' – 10 ³ / ₈ "	 DH2832-2TR 6' – 1 ¹⁵ / ₁₆ " 6' – 2 ³ / ₈ "	 DH3032-2TR 6' – 5 ¹⁵ / ₁₆ " 6' – 6 ³ / ₈ "
	3-10	 DH18310-2TR 5' – 9 ¹⁵ / ₁₆ " 5' – 10 ³ / ₈ "	 DH20310-2TR 6' – 1 ¹⁵ / ₁₆ " 6' – 2 ³ / ₈ "	 DH24310-2TR 6' – 5 ¹⁵ / ₁₆ " 6' – 6 ³ / ₈ "	 DH28310-2TR 6' – 9 ¹⁵ / ₁₆ " 6' – 10 ³ / ₈ "	
	4-2	 DH1842-2TR 6' – 1 ¹⁵ / ₁₆ " 6' – 2 ³ / ₈ "	 DH2042-2TR 6' – 5 ¹⁵ / ₁₆ " 6' – 6 ³ / ₈ "	 DH2442-2TR 6' – 9 ¹⁵ / ₁₆ " 6' – 10 ³ / ₈ "	 DH2842-2TR 7' – 1 ¹⁵ / ₁₆ " 7' – 2 ³ / ₈ "	

Optional Gothic Grille Pattern Widths



WHEN ORDERING ADD ONE OF THE FOLLOWING PREFIXES TO SPECIFY YOUR SELECTED PRODUCT: J40 = MW Pro 400 UL = MW Pro 300 WD = MW Pro 200

Standard Colonial Grille Pattern Widths





Unit Dimension	1' - 9 3/8"	2' - 1 3/8"	2' - 5 3/8"	2' - 9 3/8"	3' - 1 3/8"	3' - 5 3/8"
	1' - 10 1/2"	2' - 2 1/2"	2' - 6 1/2"	2' - 10 1/2"	3' - 2 1/2"	3' - 6 1/2"
	1-8	2-0	2-4	2-8	3-0	3-4
3-10	 DH18310AH 4' - 4 1/8" 4' - 4 3/4"	 DH20310AH 4' - 4 13/16" 4' - 5 1/16"	 DH24310AH 4' - 5 1/2" 4' - 6 1/8"	 DH28310AH 4' - 6 1/8" 4' - 6 3/4"	 DH30310AH 4' - 6 13/16" 4' - 7 1/8"	 DH34310AH 4' - 7 1/2" 4' - 8 1/8"
4-2	 DH1842AH 4' - 8 1/8" 4' - 8 3/4"	 DH2042AH 4' - 8 13/16" 4' - 9 1/16"	 DH2442AH 4' - 9 1/2" 4' - 10 1/8"	 DH2842AH 4' - 10 1/8" 4' - 10 3/4"	 DH3042AH 4' - 10 13/16" 4' - 11 1/8"	 DH3442AH 4' - 11 1/2" 5' - 0 1/8"
4-6	 DH1846AH 5' - 0 1/8" 5' - 0 3/4"	 DH2046AH 5' - 0 13/16" 5' - 1 1/16"	 DH2446AH 5' - 1 1/2" 5' - 2 1/8"	 DH2846AH 5' - 2 1/8" 5' - 2 3/4"	 DH3046AH 5' - 2 13/16" 5' - 3 1/8"	 DH3446AH 5' - 3 1/2" 5' - 4 1/8"
5-2	 DH1852AH 5' - 8 1/8" 5' - 8 3/4"	 DH2052AH 5' - 8 13/16" 5' - 9 1/16"	 DH2452AH 5' - 9 1/2" 5' - 10 1/8"	 DH2852AH 5' - 10 1/8" 5' - 10 3/4"	 DH3052AH 5' - 10 13/16" 5' - 11 1/8"	 DH3452AH 5' - 11 1/2" 6' - 0 1/8"
5-6	 DH1856AH 6' - 0 1/8" 6' - 0 3/4"	 DH2056AH 6' - 0 13/16" 6' - 1 1/16"	 DH2456AH 6' - 1 1/2" 6' - 2 1/8"	 DH2856AH 6' - 2 1/8" 6' - 2 3/4"	 DH3056AH 6' - 2 13/16" 6' - 3 1/8"	 DH3456AH 6' - 3 1/2" 6' - 4 1/8"
6-2	 DH1862AH 6' - 8 1/8" 6' - 8 3/4"	 DH2062AH 6' - 8 13/16" 6' - 9 1/16"	 DH2462AH 6' - 9 1/2" 6' - 10 1/8"	 DH2862AH 6' - 10 1/8" 6' - 10 3/4"	 DH3062AH 6' - 10 13/16" 6' - 11 1/8"	 DH3462AH 6' - 11 1/2" 7' - 0 1/8"

Unit height dimension is listed first under individual windows

Rough Opening height dimension is listed second under individual windows

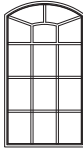
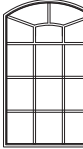
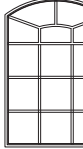
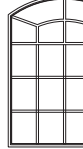
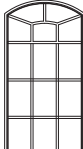
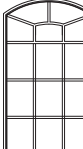
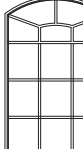
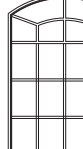
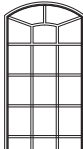
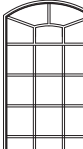
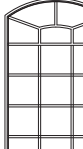
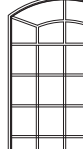
Heights

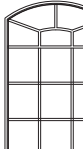
Optional Renaissance Grille Pattern Widths

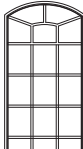
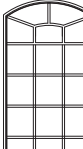
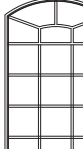
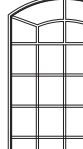
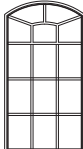
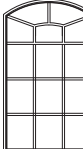
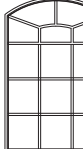
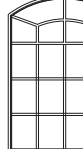
Unit Dimension Rough Opening Call Size	2' - 5 3/8"	2' - 9 3/8"	3' - 1 3/8"	3' - 5 3/8"
	2' - 6 1/2"	2' - 10 1/2"	3' - 2 1/2"	3' - 6 1/2"
	2-4	2-8	3-0	3-4
3-10	 DH24310AH 4' - 5 1/2" 4' - 6 1/8"	 DH28310AH 4' - 6 1/8" 4' - 6 3/4"	 DH30310AH 4' - 6 13/16" 4' - 7 1/8"	 DH34310AH 4' - 7 1/2" 4' - 8 1/8"
4-2	 DH2442AH 4' - 9 1/2" 4' - 10 1/8"	 DH2842AH 4' - 10 1/8" 4' - 10 3/4"	 DH3042AH 4' - 10 13/16" 4' - 11 1/8"	 DH3442AH 4' - 11 1/2" 5' - 0 1/8"
4-6	 DH2446AH 5' - 1 1/2" 5' - 2 1/8"	 DH2846AH 5' - 2 1/8" 5' - 2 3/4"	 DH3046AH 5' - 2 13/16" 5' - 3 1/8"	 DH3446AH 5' - 3 1/2" 5' - 4 1/8"
5-2	 DH2452AH 5' - 9 1/2" 5' - 10 1/8"	 DH2852AH 5' - 10 1/8" 5' - 10 3/4"	 DH3052AH 5' - 10 13/16" 5' - 11 1/8"	 DH3452AH 5' - 11 1/2" 6' - 0 1/8"
5-6	 DH2456AH 6' - 1 1/2" 6' - 2 1/8"	 DH2856AH 6' - 2 1/8" 6' - 2 3/4"	 DH3056AH 6' - 2 13/16" 6' - 3 1/8"	 DH3456AH 6' - 3 1/2" 6' - 4 1/8"
6-2	 DH2462AH 6' - 9 1/2" 6' - 10 1/8"	 DH2862AH 6' - 10 1/8" 6' - 10 3/4"	 DH3062AH 6' - 10 13/16" 6' - 11 1/8"	 DH3462AH 6' - 11 1/2" 7' - 0 1/8"

Heights

Unit height dimension is listed first under individual windows











































Rough Opening height dimension is listed second under individual windows

WHEN ORDERING ADD ONE OF THE FOLLOWING PREFIXES TO SPECIFY YOUR SELECTED PRODUCT: J40 = MW Pro 400 UL = MW Pro 300 WD = MW Pro 200

Standard Colonial Grille Pattern Widths

		1' - 9 3/8"	2' - 1 3/8"	2' - 5 3/8"	2' - 9 3/8"	3' - 1 3/8"	3' - 5 3/8"	4' - 1 3/8"	5' - 1 3/8"	6' - 1 3/8"		
		1' - 10 1/2"	2' - 2 1/2"	2' - 6 1/2"	2' - 10 1/2"	3' - 2 1/2"	3' - 6 1/2"	4' - 2 1/2"	5' - 2 1/2"	6' - 2 1/2"		
		1-8	2-0	2-4	2-8	3-0	3-4	4-0	5-0	6-0		
Heights	Unit Dimension Rough Opening Coff Size											
	0-6	 DH1806AHTN 0' - 10 15/16" 0' - 11 3/8"	 DH2006AHTN 0' - 11 5/8" 1' - 0 1/4"	 DH2406AHTN 1' - 0 5/16" 1' - 0 5/8"	 DH2806AHTN 1' - 0 5/16" 1' - 1 1/8"	 DH3006AHTN 1' - 1 5/8" 1' - 2 1/4"	 DH3406AHTN 1' - 2 5/16" 1' - 2 13/16"	 DH4006AHTN 1' - 3 3/8" 1' - 4 1/4"	 DH5006AHTN 1' - 5 5/8" 1' - 6 1/4"	 DH6006AHTN 1' - 7 5/8" 1' - 8 1/4"		
	0-10	 DH18010AHTN 1' - 2 5/16" 1' - 3 3/8"	 DH20010AHTN 1' - 3 5/8" 1' - 4 1/4"	 DH24010AHTN 1' - 4 5/16" 1' - 4 13/16"	 DH28010AHTN 1' - 4 5/16" 1' - 5 3/8"	 DH30010AHTN 1' - 5 5/8" 1' - 6 1/4"	 DH34010AHTN 1' - 6 5/16" 1' - 6 13/16"	 DH40010AHTN 1' - 7 5/8" 1' - 8 1/4"	 DH50010AHTN 1' - 9 5/8" 1' - 10 1/4"	 DH60010AHTN 1' - 11 5/8" 2' - 0 1/4"		
	1-0	 DH1810AHTN 1' - 4 5/16" 1' - 5 3/8"	 DH2010AHTN 1' - 5 5/8" 1' - 6 1/4"	 DH2410AHTN 1' - 6 5/16" 1' - 6 13/16"	 DH2810AHTN 1' - 6 5/16" 1' - 7 3/8"	 DH3010AHTN 1' - 7 5/8" 1' - 8 1/4"	 DH3410AHTN 1' - 8 5/16" 1' - 8 13/16"	 DH4010AHTN 1' - 9 5/8" 1' - 10 1/4"	 DH5010AHTN 1' - 11 5/8" 2' - 0 1/4"	 DH6010AHTN 2' - 1 3/8" 2' - 2 1/4"		
	1-2	 DH1812AHTN 1' - 6 5/16" 1' - 7 3/8"	 DH2012AHTN 1' - 7 5/8" 1' - 8 1/4"	 DH2412AHTN 1' - 8 5/16" 1' - 8 13/16"	 DH2812AHTN 1' - 8 5/16" 1' - 9 3/8"	 DH3012AHTN 1' - 9 5/8" 1' - 10 1/4"	 DH3412AHTN 1' - 10 5/16" 1' - 10 13/16"	 DH4012AHTN 1' - 11 5/8" 2' - 0 1/4"	 DH5012AHTN 2' - 1 5/8" 2' - 2 1/4"	 DH6012AHTN 2' - 3 5/8" 2' - 4 1/4"		
2-0	 DH1820AHTN 2' - 6 5/16" 2' - 6 13/16"	 DH2020AHTN 2' - 6 5/8" 2' - 7 1/2"	 DH2420AHTN 2' - 7 5/16" 2' - 8 3/16"	 DH2820AHTN 2' - 8 5/16" 2' - 8 13/16"	 DH3020AHTN 2' - 8 5/8" 2' - 9 1/2"	 DH3420AHTN 2' - 9 5/16" 2' - 10 3/16"	 DH4020AHTN 2' - 10 5/8" 2' - 11 1/2"	 DH5020AHTN 3' - 0 5/8" 3' - 1 1/2"	 DH6020AHTN 3' - 2 5/8" 3' - 3 1/2"			

Optional Renaissance Grille Pattern Widths

		2' - 5 3/8"	2' - 9 3/8"	3' - 1 3/8"	3' - 5 3/8"	4' - 1 3/8"	5' - 1 3/8"	6' - 1 3/8"
		2' - 6 1/2"	2' - 10 1/2"	3' - 2 1/2"	3' - 6 1/2"	4' - 2 1/2"	5' - 2 1/2"	6' - 2 1/2"
		2-4	2-8	3-0	3-4	4-0	5-0	6-0
Heights	Unit Dimension							
	Rough Opening							
	Grille Size							
	0-6	 DH2406AHTN 1' - 0 3/16" 1' - 0 15/16"	 DH2806AHTN 1' - 0 5/16" 1' - 1 3/16"	 DH3006AHTN 1' - 1 5/8" 1' - 2 1/4"	 DH3406AHTN 1' - 2 5/16" 1' - 2 15/16"	 DH4006AHTN 1' - 3 5/8" 1' - 4 1/4"	 DH5006AHTN 1' - 5 5/8" 1' - 6 1/4"	 DH6006AHTN 1' - 7 5/8" 1' - 8 1/4"
	0-10	 DH24010AHTN 1' - 4 5/16" 1' - 4 15/16"	 DH28010AHTN 1' - 4 15/16" 1' - 5 3/8"	 DH30010AHTN 1' - 5 5/8" 1' - 6 1/4"	 DH34010AHTN 1' - 6 5/16" 1' - 6 15/16"	 DH40010AHTN 1' - 7 5/8" 1' - 8 1/4"	 DH50010AHTN 1' - 9 5/8" 1' - 10 1/4"	 DH60010AHTN 1' - 11 5/8" 2' - 0 1/4"
	1-0	 DH2410AHTN 1' - 6 5/16" 1' - 6 15/16"	 DH2810AHTN 1' - 6 15/16" 1' - 7 3/8"	 DH3010AHTN 1' - 7 5/8" 1' - 8 1/4"	 DH3410AHTN 1' - 8 5/16" 1' - 8 15/16"	 DH4010AHTN 1' - 9 5/8" 1' - 10 1/4"	 DH5010AHTN 1' - 11 5/8" 2' - 0 1/4"	 DH6010AHTN 2' - 1 5/8" 2' - 2 1/4"
1-2	 DH2412AHTN 1' - 8 5/16" 1' - 8 15/16"	 DH2812AHTN 1' - 8 15/16" 1' - 9 3/8"	 DH3012AHTN 1' - 9 5/8" 1' - 10 1/4"	 DH3412AHTN 1' - 10 5/16" 1' - 10 15/16"	 DH4012AHTN 1' - 11 5/8" 2' - 0 1/4"	 DH5012AHTN 2' - 1 5/8" 2' - 2 1/4"	 DH6012AHTN 2' - 3 5/8" 2' - 4 1/4"	
2-0	 DH2420AHTN 2' - 7 5/16" 2' - 8 3/16"	 DH2820AHTN 2' - 8 3/16" 2' - 8 13/16"	 DH3020AHTN 2' - 8 7/8" 2' - 9 1/2"	 DH3420AHTN 2' - 9 9/16" 2' - 10 3/16"	 DH4020AHTN 2' - 10 3/16" 2' - 11 1/2"	 DH5020AHTN 3' - 0 1/8" 3' - 1 1/2"	 DH6020AHTN 3' - 2 1/8" 3' - 3 1/2"	
								





















WHEN ORDERING ADD ONE OF THE FOLLOWING PREFIXES TO SPECIFY YOUR SELECTED PRODUCT: J40 = MW Pro 400 UL = MW Pro 300 WD = MW Pro 200

Standard Colonial Grille Pattern Widths

Heights	Standard Colonial Grille Pattern Widths				
	4' - 2 3/4"	4' - 10 3/4"	5' - 6 3/4"	6' - 2 3/4"	
	4' - 3 7/8"	4' - 11 7/8"	5' - 7 7/8"	6' - 3 7/8"	
Unit Dimension	2-0 Twin		2-4 Twin	2-8 Twin	3-0 Twin
Rough Opening	2-0 Twin		2-4 Twin	2-8 Twin	3-0 Twin
Coll Size	2-0 Twin		2-4 Twin	2-8 Twin	3-0 Twin
0-6	 DH2006-2AHTN 1' - 3 7/8" 1' - 4 1/2"	 DH2406-2AHTN 1' - 5 3/8" 1' - 5 13/16"	 DH2806-2AHTN 1' - 6 1/2" 1' - 7 1/8"	 DH3006-2AHTN 1' - 7 7/8" 1' - 8 1/2"	
0-10	 DH2010-2AHTN 1' - 7 7/8" 1' - 8 1/2"	 DH2410-2AHTN 1' - 9 3/8" 1' - 9 13/16"	 DH2810-2AHTN 1' - 10 1/2" 1' - 11 1/8"	 DH3010-2AHTN 1' - 11 7/8" 2' - 0 1/2"	
1-0	 DH2010-2AHTN 1' - 9 7/8" 1' - 10 1/2"	 DH2410-2AHTN 1' - 11 3/8" 1' - 11 13/16"	 DH2810-2AHTN 2' - 0 1/2" 2' - 1 1/8"	 DH3010-2AHTN 2' - 1 7/8" 2' - 2 1/2"	
1-2	 DH2012-2AHTN 1' - 11 7/8" 2' - 0 1/2"	 DH2412-2AHTN 2' - 1 3/8" 2' - 1 13/16"	 DH2812-2AHTN 2' - 2 1/2" 2' - 3 1/8"	 DH3012-2AHTN 2' - 3 7/8" 2' - 4 1/2"	
2-0	 DH2020-2AHTN 2' - 11 1/8" 2' - 11 3/4"	 DH2420-2AHTN 3' - 0 7/16" 3' - 1 1/8"	 DH2820-2AHTN 3' - 1 3/4" 3' - 2 3/8"	 DH3020-2AHTN 3' - 3 1/8" 3' - 3 3/4"	

Unit height dimension is listed first under individual windows
Rough Opening height dimension is listed second under individual windows

Optional Renaissance Grille Pattern Widths

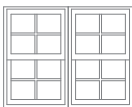
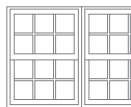
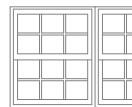
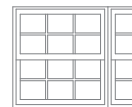
Heights	Optional Renaissance Grille Pattern Widths			
	4' – 2 3/4"	4' – 10 3/4"	5' – 6 3/4"	6' – 2 3/4"
	4' – 3 7/8"	4' – 11 1/8"	5' – 7 7/8"	6' – 3 7/8"
Unit Dimension	2-0 Twin	2-4 Twin	2-8 Twin	3-0 Twin
0-6	 DH2006-2AHTN 1' – 3 7/8" 1' – 4 1/2"	 DH2406-2AHTN 1' – 5 3/16" 1' – 5 13/16"	 DH2806-2AHTN 1' – 6 1/2" 1' – 7 1/8"	 DH3006-2AHTN 1' – 7 7/8" 1' – 8 1/2"
0-10	 DH2010-2AHTN 1' – 7 7/8" 1' – 8 1/2"	 DH2410-2AHTN 1' – 9 3/16" 1' – 9 13/16"	 DH2810-2AHTN 1' – 10 1/2" 1' – 11 1/8"	 DH3010-2AHTN 1' – 11 7/8" 2' – 0 1/2"
1-0	 DH2010-2AHTN 1' – 9 7/8" 1' – 10 1/2"	 DH2410-2AHTN 1' – 11 3/16" 1' – 11 13/16"	 DH2810-2AHTN 2' – 0 1/2" 2' – 1 1/8"	 DH3010-2AHTN 2' – 1 7/8" 2' – 2 1/2"
1-2	 DH2012-2AHTN 1' – 11 7/8" 2' – 0 1/2"	 DH2412-2AHTN 2' – 1 3/16" 2' – 1 13/16"	 DH2812-2AHTN 2' – 2 1/2" 2' – 3 1/8"	 DH3012-2AHTN 2' – 3 7/8" 2' – 4 1/2"
2-0	 DH2020-2AHTN 2' – 11 1/8" 2' – 11 3/4"	 DH2420-2AHTN 3' – 0 7/16" 3' – 1 1/16"	 DH2820-2AHTN 3' – 1 3/4" 3' – 2 3/8"	 DH3020-2AHTN 3' – 3 1/8" 3' – 3 3/4"
				

WHEN ORDERING ADD ONE OF THE FOLLOWING PREFIXES TO SPECIFY YOUR SELECTED PRODUCT: J40 = MW Pro 400 UL = MW Pro 300 WD = MW Pro 200

Single Widths

Unit Dimension	1'-9 3/8"	2'-1 3/8"	2'-5 3/8"	2'-9 3/8"	3'-1 3/8"	3'-5 3/8"	3'-9 3/8"
	1'-10 1/2"	2'-2 1/2"	2'-6 1/2"	2'-10 1/2"	3'-2 1/2"	3'-6 1/2"	3'-10 1/2"
	1-8	2-0	2-4	2-8	3-0	3-4	3-8 ‡
0-11 3/8"	DH18010TN	DH20010TN	DH24010TN	DH28010TN	DH30010TN	DH34010TN	DH38010TN
1-1 3/8"	DH1810TN	DH2010TN	DH2410TN	DH2810TN	DH3010TN	DH3410TN	DH3810TN
1-3 3/8"	DH1812TN	DH2012TN	DH2412TN	DH2812TN	DH3012TN	DH3412TN	DH3812TN
2-2 5/8"	DH1820TN	DH2020TN	DH2420TN	DH2820TN	DH3020TN	DH3420TN	DH3820TN
2-7 1/8"	DH1824TN	DH2024TN	DH2424TN	DH2824TN	DH3024TN	DH3424TN	DH3824TN

‡ NOTE: 3-8 Widths Not Available in MW Pro 400 Series

Twin Widths

Unit Dimension	4'-2 3/4"	4'-10 3/4"	5'-6 3/4"	6'-2 3/4"
	4'-3 7/8"	4'-11 7/8"	5'-7 7/8"	6'-3 7/8"
	2-0 Twin	2-4 Twin	2-8 Twin	3-0 Twin
0-11 3/8"	DH20010-2TN	DH24010-2TN	DH28010-2TN	DH30010-2TN
1-1 3/8"	DH2010-2TN	DH2410-2TN	DH2810-2TN	DH3010-2TN
1-3 3/8"	DH2012-2TN	DH2412-2TN	DH2812-2TN	DH3012-2TN
2-2 5/8"	DH2020-2TN	DH2420-2TN	DH2820-2TN	DH3020-2TN
2-7 1/8"	DH2024-2TN	DH2424-2TN	DH2824-2TN	DH3024-2TN

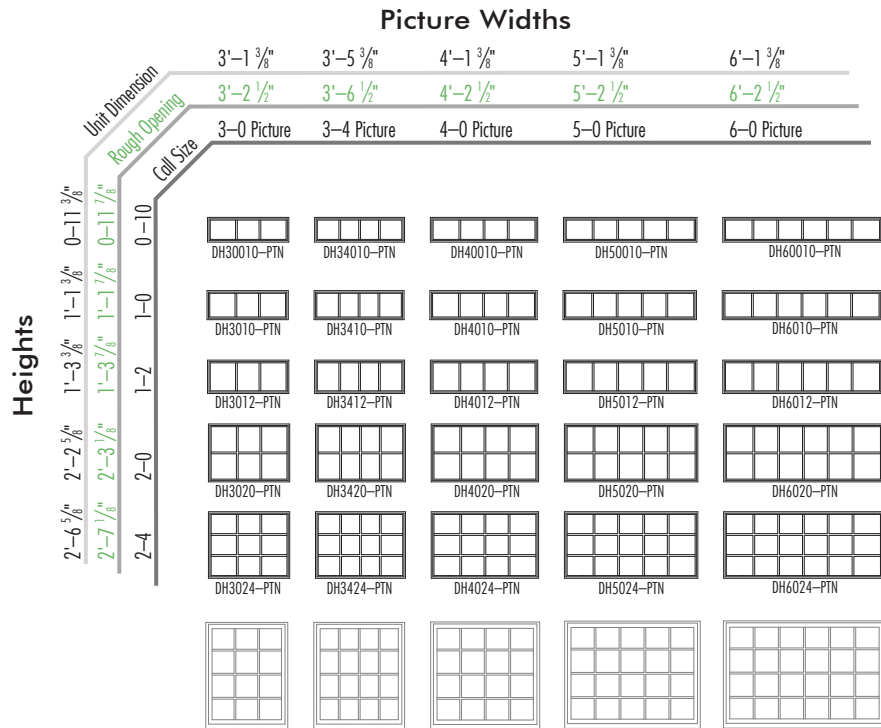

WHEN ORDERING ADD ONE OF THE FOLLOWING PREFIXES TO SPECIFY YOUR SELECTED PRODUCT: J40 = MW Pro 400 UL = MW Pro 300 WD = MW Pro 200

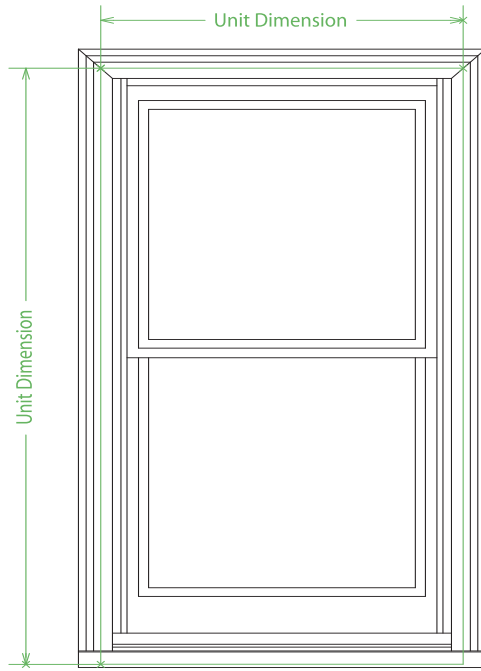

To calculate unit dimension on multiple units, add actual unit dimensions together.

Operating Units, WIDTH

CALL SIZE (WIDTH)	1-8	2-0	2-4	2-8	3-0	3-4	3-8
SINGLE	21 ³ / ₈	25 ³ / ₈	29 ³ / ₈	33 ³ / ₈	37 ³ / ₈	41 ³ / ₈	45 ³ / ₈
TWIN	42 ³ / ₄	50 ³ / ₄	58 ³ / ₄	66 ³ / ₄	74 ³ / ₄	82 ³ / ₄	90 ³ / ₄
TRIPLE	64 ¹ / ₈	76 ¹ / ₈	88 ¹ / ₈	100 ¹ / ₈	112 ¹ / ₈	N/A	N/A
FOUR WIDE	85 ¹ / ₂	101 ¹ / ₂	117 ¹ / ₂	N/A	N/A	N/A	N/A

Operating & Stationary Units, HEIGHT

CALL SIZE (HEIGHT)	HEIGHT IN INCHES
2-10	37
3-2	41
3-10	49
4-2	53
4-6	57
5-2	65
5-6C	69
5-6E	69
6-2	77

Stationary Units, WIDTH

CALL SIZE (WIDTH)	1-0	1-2	1-4	1-8	2-0	2-4	2-8
SINGLE	13 ³ / ₈	15 ³ / ₈	17 ³ / ₈	21 ³ / ₈	25 ³ / ₈	29 ³ / ₈	33 ³ / ₈
TWIN	26 ³ / ₄	30 ³ / ₄	34 ³ / ₄	42 ³ / ₄	50 ³ / ₄	58 ³ / ₄	66 ³ / ₄
TRIPLE	40 ¹ / ₈	46 ¹ / ₈	52 ¹ / ₈	64 ¹ / ₈	76 ¹ / ₈	88 ¹ / ₈	100 ¹ / ₈

Stationary Units, WIDTH

CALL SIZE (WIDTH)	3-0	3-4	4-0	5-0	6-0
SINGLE	37 ³ / ₈	41 ³ / ₈	49 ³ / ₈	61 ³ / ₈	73 ³ / ₈
TWIN	74 ³ / ₄	82 ³ / ₄	98 ³ / ₄	N/A	N/A
TRIPLE	112 ¹ / ₈	N/A	N/A	N/A	N/A

Transom Units, HEIGHT

CALL SIZE (HEIGHT)	HEIGHT IN INCHES
0-10	11 ³ / ₈
1-0	13 ³ / ₈
1-2	15 ³ / ₈
2-0	26 ⁵ / ₈
2-4	30 ⁵ / ₈

400 Series Double Hung – Net Clear & Daylight Opening Dimensions

Operating Units

Call Size	Clear Opening Width	Clear Opening Height	Clear Opening S.F.	Daylight Opening S.F.
J40DH18210	18.063	13.375	1.68	3.0
32	18.063	15.375	1.93	3.4
310	18.063	19.375	2.43	4.3
42	18.063	21.375	2.68	4.7
46	18.063	23.375	2.93	5.2
52	18.063	27.375	3.43	6.0
56E	18.063	29.375	3.68	6.5
56C	18.063	23.375	2.93	6.5
62	18.063	33.375	4.19	7.3
J40DH20210	22.063	13.375	2.05	3.7
32	22.063	15.375	2.36	4.3
310	22.063	19.375	2.97	5.4
42	22.063	21.375	3.27	5.9
46	22.063	23.375	3.58	6.5
52	22.063	27.375	4.19	7.6
56E	22.063	29.375	4.50	8.1
56C	22.063	23.375	3.58	8.1
62	22.063	33.375	5.11	9.2
J40DH24210	26.063	13.375	2.42	4.5
32	26.063	15.375	2.78	5.2
310	26.063	19.375	3.51	6.5
42	26.063	21.375	3.87	7.1
46	26.063	23.375	4.23	7.8
52	26.063	27.375	4.95	9.1
56E	26.063	29.375	5.32	9.8
56C	26.063	23.375	4.23	9.8
62	26.063	33.375	6.04	11.1
J40DH28210	30.063	13.375	2.79	5.3
32	30.063	15.375	3.21	6.0
310	30.063	19.375	4.04	7.6
42	30.063	21.375	4.46	8.3
46	30.063	23.375	4.88	9.1
52	30.063	27.375	5.72	10.7
56E	30.063	29.375	6.13	11.4
56C	30.063	23.375	4.88	11.4
62	30.063	33.375	6.97	13.0
J40DH30210	34.063	13.375	3.16	6.0
32	34.063	15.375	3.64	6.9
310	34.063	19.375	4.58	8.7
42	34.063	21.375	5.06	9.5
46	34.063	23.375	5.53	10.4
52	34.063	27.375	6.48	12.2
56E	34.063	29.375	6.95	13.1
56C	34.063	23.375	5.53	13.1
62	34.063	33.375	7.89	14.8
J40DH34210	38.063	13.375	3.54	6.8
32	38.063	15.375	4.06	7.8
310	38.063	19.375	5.12	9.8
42	38.063	21.375	5.65	10.8
46	38.063	23.375	6.18	11.7
52	38.063	27.375	7.24	13.7
56E	38.063	29.375	7.76	14.7
56C	38.063	23.375	6.18	14.7
62	38.063	33.375	8.82	16.7

Stationary Units

Call Size	Daylight Opening S.F.	Call Size	Daylight Opening S.F.
J40DH18210P	3.3	J40DH34210P	7.4
32	3.8	32	8.4
310	4.7	310	10.4
42	5.2	42	11.4
46	5.6	46	12.4
52	6.5	52	14.5
56	7.0	56	15.5
62	7.9	62	17.5
J40DH20210P	4.1	J40DH40210P	9.0
32	4.7	32	10.2
310	5.8	310	12.7
42	6.4	42	13.9
46	7.0	46	15.1
52	8.1	52	17.6
56	8.7	56	18.9
62	9.8	62	21.3
J40DH24210P	4.9	J40DH50210P	11.4
32	5.6	32	13.0
310	7.0	310	16.1
42	7.7	42	17.7
46	8.3	46	19.2
52	9.7	52	22.4
56	10.4	56	23.9
62	11.7	62	27.1
J40DH28210P	5.7	J40DH60210P	13.8
32	6.5	32	15.7
310	8.1	310	19.5
42	8.9	42	21.4
46	9.7	46	23.3
52	11.3	52	27.1
56	12.1	56	29.0
62	13.7	62	32.8
J40DH30210P	6.6		
32	7.5		
310	9.3		
42	10.2		
46	11.1		
52	12.9		
56	13.8		
62	15.6		

NOTE: Units listed in green satisfy IRC egress requirements. Check with your local code official to confirm egress requirements in your area.

Operating Units

Call Size	Clear Opening Width	Clear Opening Height	Clear Opening S.F.	Daylight Opening S.F.
ULDH18210	18.125	14.375	1.81	3.0
32	18.125	16.375	2.06	3.4
310	18.125	20.375	2.56	4.3
42	18.125	22.375	2.82	4.7
46	18.125	24.375	3.07	5.1
52	18.125	28.375	3.57	6.0
56E	18.125	30.375	3.82	6.4
56C	18.125	24.375	3.07	6.4
62	18.125	34.375	4.33	7.3
ULDH20210	22.125	14.375	2.21	3.7
32	22.125	16.375	2.52	4.3
310	22.125	20.375	3.13	5.3
42	22.125	22.375	3.44	5.9
46	22.125	24.375	3.75	6.4
52	22.125	28.375	4.36	7.5
56E	22.125	30.375	4.67	8.1
56C	22.125	24.375	3.75	8.1
62	22.125	34.375	5.28	9.2
ULDH24210	26.125	14.375	2.61	4.5
32	26.125	16.375	2.97	5.1
310	26.125	20.375	3.70	6.4
42	26.125	22.375	4.06	7.1
46	26.125	24.375	4.42	7.8
52	26.125	28.375	5.15	9.1
56E	26.125	30.375	5.51	9.7
56C	26.125	24.375	4.42	9.7
62	26.125	34.375	6.28	11.0
ULDH28210	30.125	14.375	3.01	5.2
32	30.125	16.375	3.43	6.0
310	30.125	20.375	4.26	7.5
42	30.125	22.375	4.68	8.3
46	30.125	24.375	5.10	9.1
52	30.125	28.375	5.94	10.6
56E	30.125	30.375	6.35	11.4
56C	30.125	24.375	5.10	11.4
62	30.125	34.375	7.19	12.9
ULDH30210	34.125	14.375	3.41	6.0
32	34.125	16.375	3.88	6.9
310	34.125	20.375	4.83	8.6
42	34.125	22.375	5.30	9.5
46	34.125	24.375	5.78	10.4
52	34.125	28.375	6.72	12.1
56E	34.125	30.375	7.20	13.0
56C	34.125	24.375	5.78	13.0
62	34.125	34.375	8.15	14.8
ULDH34210	38.125	14.375	3.81	6.7
32	38.125	16.375	4.34	7.7
310	38.125	20.375	5.39	9.7
42	38.125	22.375	5.92	10.7
46	38.125	24.375	6.45	11.7
52	38.125	28.375	7.51	13.7
56E	38.125	30.375	8.04	14.7
56C	38.125	24.375	6.45	14.7
62	38.125	34.375	9.10	16.6

Stationary Units

Call Size	Daylight Opening S.F.	Call Size	Daylight Opening S.F.
ULDH10210P	1.7	ULDH30210P	6.5
32	1.9	32	7.4
310	2.4	310	9.2
42	2.6	42	10.1
46	2.9	46	11.1
52	3.3	52	12.8
56	3.6	56	13.7
62	4.0	62	15.5
ULDH18210P	3.3	ULDH34210P	7.3
32	3.7	32	8.3
310	4.6	310	10.3
42	5.1	42	11.3
46	5.6	46	12.3
52	6.5	52	14.3
56	6.9	56	15.4
62	7.8	62	17.4
ULDH20210P	4.1	ULDH40210P	8.8
32	4.6	32	10.1
310	5.8	310	12.5
42	6.3	42	13.8
46	6.9	46	15.0
52	8.0	52	17.5
56	8.6	56	18.7
62	9.7	62	21.2
ULDH24210P	4.9	ULDH50210P	11.2
32	5.5	32	12.8
310	6.9	310	15.9
42	7.6	42	17.5
46	8.3	46	19.1
52	9.6	52	22.2
56	10.3	56	23.8
62	11.7	62	26.9
ULDH28210P	5.7	ULDH60210P	13.6
32	6.5	32	15.5
310	8.0	310	19.3
42	8.8	42	21.2
46	9.6	46	23.1
52	11.2	52	26.9
56	12.0	56	28.8
62	13.6	62	32.6

NOTE: Units listed in green satisfy IRC egress requirements. Check with your local code official to confirm egress requirements in your area.

Operating Units

Call Size	Clear Opening Width	Clear Opening Height	Clear Opening S.F.	Daylight Opening S.F.
WDDH18210	17.750	14.625	1.80	3.0
32	17.750	16.625	2.05	3.4
310	17.750	20.625	2.54	4.3
42	14.778	22.625	2.79	4.7
46	17.750	24.625	3.04	5.2
52	17.750	28.625	3.53	6.0
56E	17.750	30.625	3.77	6.5
56C	17.750	24.625	3.04	6.5
62	17.750	34.625	4.27	7.3
WDDH20210	21.750	14.625	2.21	3.7
32	21.750	16.625	2.51	4.3
310	21.750	20.625	3.12	5.4
42	21.750	22.625	3.42	5.9
46	21.750	24.625	3.72	6.5
52	21.750	28.625	4.32	7.6
56E	21.750	30.625	4.63	8.1
56C	21.750	24.625	3.72	8.1
62	21.750	34.625	5.23	9.2
WDDH24210	25.750	14.625	2.62	4.5
32	25.750	16.625	2.97	5.2
310	25.750	20.625	3.69	6.5
42	25.750	22.625	4.05	7.1
46	25.750	24.625	4.40	7.8
52	25.750	28.625	5.12	9.1
56E	25.750	30.625	5.48	9.8
56C	25.750	24.625	4.40	9.8
62	25.750	34.625	6.19	11.1
WDDH28210	29.750	14.625	3.02	5.3
32	29.750	16.625	3.43	6.0
310	29.750	20.625	4.26	7.6
42	29.750	22.625	4.67	8.3
46	29.750	24.625	5.09	9.1
52	29.750	28.625	5.91	10.6
56E	29.750	30.625	6.33	11.4
56C	29.750	24.625	5.09	11.4
62	29.750	34.625	7.15	13.0
WDDH30210	33.750	14.625	3.43	6.0
32	33.750	16.625	3.90	6.9
310	33.750	20.625	4.83	8.7
42	33.750	22.625	5.30	9.5
46	33.750	24.625	5.77	10.4
52	33.750	28.625	6.71	12.2
56E	33.750	30.625	7.18	13.1
56C	33.750	24.625	5.77	13.1
62	33.750	34.625	8.12	14.8
WDDH34210	37.750	14.625	3.83	6.8
32	37.750	16.625	4.36	7.8
310	37.750	20.625	5.41	9.8
42	37.750	22.625	5.93	10.7
46	37.750	24.625	6.46	11.7
52	37.750	28.625	7.50	13.7
56E	37.750	30.625	8.03	14.7
56C	37.750	24.625	6.46	14.7
62	37.750	34.625	9.08	16.7

Call Size	Clear Opening Width	Clear Opening Height	Clear Opening S.F.	Daylight Opening S.F.
WDDH38210	41.750	14.625	4.24	7.5
32	41.750	16.625	4.82	8.6
310	41.750	20.625	5.98	10.9
42	41.750	22.625	6.56	12.0
46	41.750	24.625	7.14	13.1
52	41.750	28.625	8.30	15.3

NOTE: Units listed in green satisfy IRC egress requirements. Check with your local code official to confirm egress requirements in your area.

Stationary Units

Call Size	Daylight Opening S.F.	Call Size	Daylight Opening S.F.
WDDH10210P	1.5	WDDH30210P	6.3
32	1.7	32	7.1
310	2.1	310	8.9
42	2.3	42	9.8
46	2.6	46	10.6
52	3.0	52	12.4
56	3.2	56	13.3
62	3.6	62	15.0
WDDH18210P	3.1	WDDH34210P	7.1
32	3.5	32	8.0
310	4.4	310	10.0
42	4.8	42	11.0
46	5.2	46	12.0
52	6.1	52	14.0
56	6.5	56	15.0
62	7.4	62	16.9
WDDH20210P	3.9	WDDH40210P	8.6
32	4.4	32	9.9
310	5.5	310	12.3
42	6.1	42	13.5
46	6.6	46	14.7
52	7.7	52	17.1
56	8.2	56	18.3
62	9.3	62	20.7
WDDH24210P	4.7	WDDH50210P	11.0
32	5.3	32	12.6
310	6.6	310	15.7
42	7.3	42	17.2
46	7.9	46	18.7
52	9.3	52	21.8
56	9.9	56	23.4
62	11.2	62	26.5
WDDH28210P	5.5	WDDH60210P	13.4
32	6.2	32	15.3
310	7.8	310	19.0
42	8.5	42	20.9
46	9.3	46	22.8
52	10.8	52	26.5
56	11.6	56	28.4
62	13.1	62	32.2

300 & 400 Double Hung – Bay Window Details

MW PRO SERIES 400, 300, 200

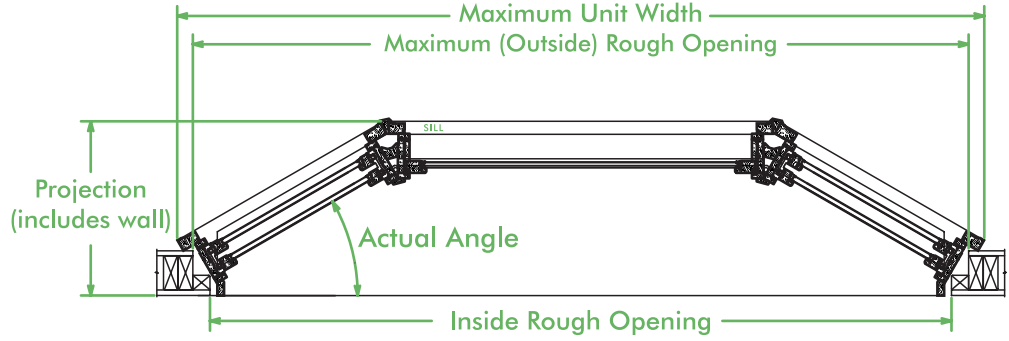
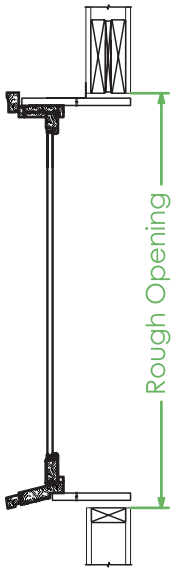

30° Angle Bay with 1-8 Flankers

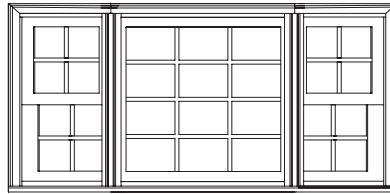

30° Angle Bay with 2-0 Flankers

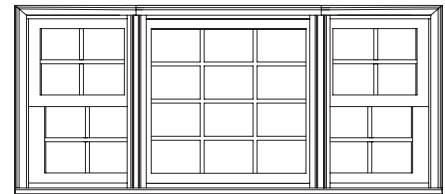

HEIGHTS			
Call Size	Bay Unit	Inside Dimension	Rough Opening
2/10	37 ^{-3/4}	35 ^{-11/16}	38 ^{-1/4}
3/2	41 ^{-3/4}	39 ^{-11/16}	42 ^{-1/4}
3/10	49 ^{-3/4}	47 ^{-11/16}	50 ^{-1/4}
4/2	53 ^{-3/4}	51 ^{-11/16}	54 ^{-1/4}
4/6	57 ^{-3/4}	55 ^{-11/16}	58 ^{-1/4}
5/2	65 ^{-3/4}	63 ^{-11/16}	66 ^{-1/4}
5/6	69 ^{-3/4}	67 ^{-11/16}	70 ^{-1/4}
6/2	77 ^{-3/4}	75 ^{-11/16}	78 ^{-1/4}

WIDTHS					
Call Size	Max. Unit	Max. Ext. Rough Opening	Inside Rough Opening	Projection	Actual Angle
DH1830xx-30	82 ^{-17/32}	79 ^{-9/32}	75 ^{-25/32}	17 ^{-7/8}	30°
DH1834xx-30	86 ^{-17/32}	83 ^{-9/32}	79 ^{-25/32}	17 ^{-7/8}	30°
DH1840xx-30	94 ^{-17/32}	91 ^{-9/32}	87 ^{-25/32}	17 ^{-7/8}	30°
DH1850xx-30	106 ^{-17/32}	103 ^{-9/32}	99 ^{-25/32}	17 ^{-7/8}	30°
DH1860xx-30	118 ^{-17/32}	115 ^{-9/32}	111 ^{-25/32}	17 ^{-7/8}	30°
DH2030xx-30	89 ^{-13/32}	86 ^{-5/32}	82 ^{-21/32}	19 ^{-7/8}	30°
DH2034xx-30	93 ^{-13/32}	90 ^{-5/32}	86 ^{-21/32}	19 ^{-7/8}	30°
DH2040xx-30	101 ^{-13/32}	98 ^{-5/32}	94 ^{-21/32}	19 ^{-7/8}	30°
DH2050xx-30	113 ^{-13/32}	110 ^{-5/32}	106 ^{-21/32}	19 ^{-7/8}	30°

Note: Projections include 4^{-9/16}" wall.

45° Angle Bay with 1-8 Flankers

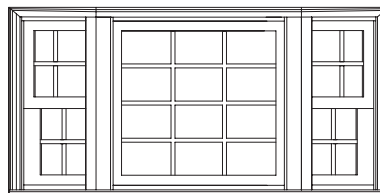

45° Angle Bay with 2-0 Flankers

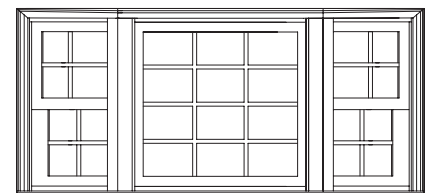

WIDTHS					
Call Size	Max. Unit	Max. Ext. Rough Opening	Inside Rough Opening	Projection	Actual Angle
DH1830xx-45	77 ^{-13/16}	73 ^{-5/8}	68 ^{-5/8}	23 ^{-5/16}	45°
DH1834xx-45	81 ^{-13/16}	77 ^{-5/8}	72 ^{-5/8}	23 ^{-5/16}	45°
DH1840xx-45	89 ^{-13/16}	85 ^{-5/8}	80 ^{-5/8}	23 ^{-5/16}	45°
DH1850xx-45	101 ^{-13/16}	97 ^{-5/8}	92 ^{-5/8}	23 ^{-5/16}	45°
DH1860xx-45	113 ^{-13/16}	109 ^{-5/8}	104 ^{-5/8}	23 ^{-5/16}	45°
DH2030xx-45	83 ^{-7/16}	79 ^{-1/4}	74 ^{-1/4}	26 ^{-1/8}	45°
DH2034xx-45	87 ^{-7/16}	83 ^{-1/4}	78 ^{-1/4}	26 ^{-1/8}	45°
DH2040xx-45	95 ^{-7/16}	91 ^{-1/4}	86 ^{-1/4}	26 ^{-1/8}	45°
DH2050xx-45	107 ^{-7/16}	103 ^{-1/4}	98 ^{-1/4}	26 ^{-1/8}	45°
DH2060xx-45	119 ^{-7/16}	115 ^{-1/4}	110 ^{-1/4}	26 ^{-1/8}	45°

NOTE:
WHEN ORDERING ADD ONE OF THE FOLLOWING PREFIXES TO SPECIFY YOUR SELECTED PRODUCT:

J40 = MW Pro 400
UL = MW Pro 300

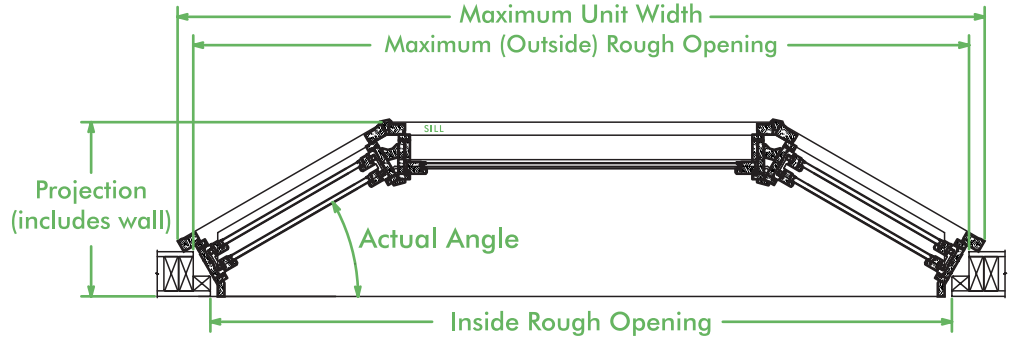

30° Angle Bay with 1-8 Flankers

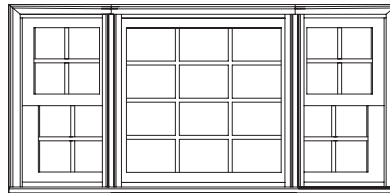

30° Angle Bay with 2-0 Flankers

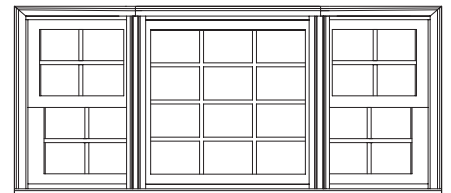

HEIGHTS			
Call Size	Bay Unit	Inside Dimension	Rough Opening
2/10	37 ^{-3/4}	35 ^{-9/16}	38 ^{-5/16}
3/2	41 ^{-3/4}	39 ^{-9/16}	42 ^{-5/16}
3/10	49 ^{-3/4}	47 ^{-9/16}	50 ^{-5/16}
4/2	53 ^{-3/4}	51 ^{-9/16}	54 ^{-5/16}
4/6	57 ^{-3/4}	55 ^{-9/16}	58 ^{-5/16}
5/2	65 ^{-3/4}	63 ^{-9/16}	66 ^{-5/16}
5/6	69 ^{-3/4}	67 ^{-9/16}	70 ^{-5/16}
6/2	77 ^{-3/4}	75 ^{-9/16}	78 ^{-5/16}

WIDTHS					
Call Size	Max. Unit	Max. Ext. Rough Opening	Inside Rough Opening	Projection	Actual Angle
WDDH1830xx-30	82 ^{-7/16}	79 ^{-1/4}	75 ^{-3/4}	17 ^{-13/16}	30°
WDDH1834xx-30	86 ^{-7/16}	83 ^{-1/4}	79 ^{-3/4}	17 ^{-13/16}	30°
WDDH1840xx-30	94 ^{-7/16}	91 ^{-1/4}	87 ^{-3/4}	17 ^{-13/16}	30°
WDDH1850xx-30	106 ^{-7/16}	103 ^{-1/4}	99 ^{-3/4}	17 ^{-13/16}	30°
WDDH1860xx-30	118 ^{-7/16}	115 ^{-1/4}	111 ^{-3/4}	17 ^{-13/16}	30°
WDDH2030xx-30	89 ^{-3/8}	86 ^{-3/16}	82 ^{-11/16}	19 ^{-13/16}	30°
WDDH2034xx-30	93 ^{-3/8}	90 ^{-3/16}	86 ^{-11/16}	19 ^{-13/16}	30°
WDDH2040xx-30	101 ^{-3/8}	98 ^{-3/16}	94 ^{-11/16}	19 ^{-13/16}	30°
WDDH2050xx-30	113 ^{-3/8}	110 ^{-3/16}	106 ^{-11/16}	19 ^{-13/16}	30°

Note: Projections include 4^{-9/16}" wall.

45° Angle Bay with 1-8 Flankers

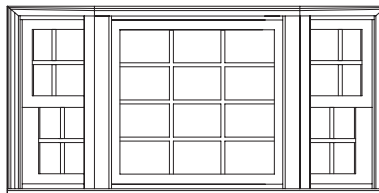

45° Angle Bay with 2-0 Flankers

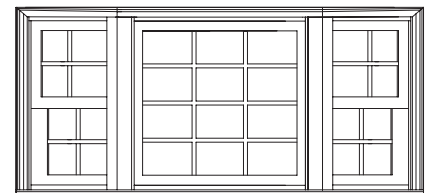

WIDTHS					
Call Size	Max. Unit	Max. Ext. Rough Opening	Inside Rough Opening	Projection	Actual Angle
WDDH1830xx-45	77 ^{-11/16}	73 ^{-5/8}	68 ^{-5/8}	23 ^{-1/4}	45°
WDDH1834xx-45	81 ^{-11/16}	77 ^{-5/8}	72 ^{-5/8}	23 ^{-1/4}	45°
WDDH1840xx-45	89 ^{-11/16}	85 ^{-5/8}	80 ^{-5/8}	23 ^{-1/4}	45°
WDDH1850xx-45	101 ^{-11/16}	97 ^{-5/8}	92 ^{-5/8}	23 ^{-1/4}	45°
WDDH1860xx-45	113 ^{-11/16}	109 ^{-5/8}	104 ^{-5/8}	23 ^{-1/4}	45°
WDDH2030xx-45	83 ^{-5/16}	79 ^{-1/4}	74 ^{-1/4}	26 ^{-1/8}	45°
WDDH2034xx-45	87 ^{-5/16}	83 ^{-1/4}	78 ^{-1/4}	26 ^{-1/8}	45°
WDDH2040xx-45	95 ^{-5/16}	91 ^{-1/4}	86 ^{-1/4}	26 ^{-1/8}	45°
WDDH2050xx-45	107 ^{-5/16}	103 ^{-1/4}	98 ^{-1/4}	26 ^{-1/8}	45°
WDDH2060xx-45	119 ^{-5/16}	115 ^{-1/4}	110 ^{-1/4}	26 ^{-1/8}	45°

		Widths			
		1' - 4 ³ / ₄ "	2' - 9 ¹ / ₂ "	4' - 2 ¹ / ₄ "	5' - 7"
		1' - 5 ³ / ₄ "	2' - 10 ¹ / ₂ "	4' - 3 ³ / ₄ "	5' - 8"
		1-5	1-5 Twin	1-5 Triple	1-5 Quad
Heights	Unit Dimension	3' - 0"	3' - 0" ¹⁵ / ₁₆ "	3' - 0" ¹⁵ / ₁₆ "	3' - 0" ¹⁵ / ₁₆ "
	Rough Opening	3' - 4 ¹ / ₈ "	3' - 5 ⁷ / ₁₆ "	3' - 5 ⁷ / ₁₆ "	3' - 5 ⁷ / ₁₆ "
	Call Size	3-0	3-5	3-5	3-5
	WDCA1530	WDCA1530-2	WDCA1530-3	WDCA1530-4	
	WDCA1535	WDCA1535-2	WDCA1535-3	WDCA1535-4	
	WDCA1540	WDCA1540-2	WDCA1540-3	WDCA1540-4	
	WDCA1545	WDCA1545-2	WDCA1545-3	WDCA1545-4	
	WDCA1550	WDCA1550-2	WDCA1550-3	WDCA1550-4	
WDCA1555	WDCA1555-2	WDCA1555-3	WDCA1555-4		
WDCA1560	WDCA1560-2	WDCA1560-3	WDCA1560-4		
6' - 0"	6' - 0" ¹⁵ / ₁₆ "	6' - 0"	6' - 0"	6' - 0"	

Widths

Unit Dimension Rough Opening Call Size	5' – 9 1/2"	6' – 2"	6' – 10"	7' – 9 1/2"	8' – 9 1/2"
	5' – 10 1/2"	6' – 3"	6' – 11"	7' – 10 1/2"	8' – 10 1/2"
	1–5 Flankers with 3–0 Center	1–5 Flankers with 3–5 Center	1–5 Flankers with 4–0 Center	1–5 Flankers with 5–0 Center	1–5 Flankers with 6–0 Center
3' – 0"	WDCA1530/30	WDCA1530/35	WDCA1530/40	WDCA1530/50	WDCA1530/60
3' – 4 1/2"	WDCA1535/30	WDCA1535/35	WDCA1535/40	WDCA1535/50	WDCA1535/60
4' – 0 1/2"	WDCA1540/30	WDCA1540/35	WDCA1540/40	WDCA1540/50	WDCA1540/60
4' – 5"	WDCA1545/30	WDCA1545/35	WDCA1545/40	WDCA1545/50	WDCA1545/60
5' – 0"	WDCA1550/30	WDCA1550/35	WDCA1550/40	WDCA1550/50	WDCA1550/60
5' – 5"	WDCA1555/30	WDCA1555/35	WDCA1555/40	WDCA1555/50	WDCA1555/60
6' – 0"	WDCA1560/30	WDCA1560/35	WDCA1560/40	WDCA1560/50	WDCA1560/60

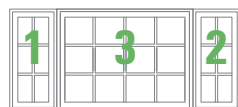

STYLE 2VB
(Shown Above)



STYLE 2VL



STYLE 2VR

Note: Viewed from exterior, Windows 1 and 2 are operating. Window 3 is stationary

		Widths			
		1' - 8 1/4"	3' - 4 1/2"	5' - 0 3/4"	6' - 9"
Unit Dimension		1' - 9 1/4"	3' - 5 1/2"	5' - 1 3/4"	6' - 10"
		1-8	1-8 Twin	1-8 Triple	1-8 Quad
Rough Opening		Call Size			
Heights	3' - 0"	WDCA1830	WDCA1830-2	WDCA1830-3	WDCA1830-4
	3' - 4 1/2"	WDCA1835	WDCA1835-2	WDCA1835-3	WDCA1835-4
	4' - 0 1/2"	WDCA1840	WDCA1840-2	WDCA1840-3	WDCA1840-4
	4' - 5"	WDCA1845	WDCA1845-2	WDCA1845-3	WDCA1845-4
	5' - 0"	WDCA1850	WDCA1850-2	WDCA1850-3	WDCA1850-4
	5' - 5"	WDCA1855	WDCA1855-2	WDCA1855-3	WDCA1855-4
	6' - 0"	WDCA1860	WDCA1860-2	WDCA1860-3	WDCA1860-4

Widths

6' – 4 1/2"	6' – 9"	7' – 5"	8' – 4 1/2"	9' – 4 1/2"
6' – 5 1/2"	6' – 10"	7' – 6"	8' – 5 1/2"	9' – 5 1/2"
1–8 Flankers with 3–0 Center	1–8 Flankers with 3–5 Center	1–8 Flankers with 4–0 Center	1–8 Flankers with 5–0 Center	1–8 Flankers with 6–0 Center







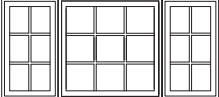
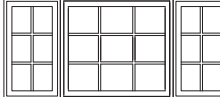
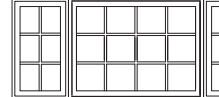
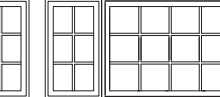
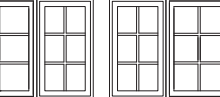
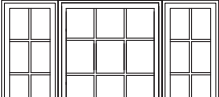
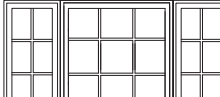
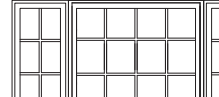
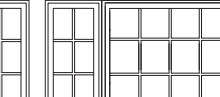
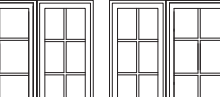
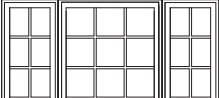
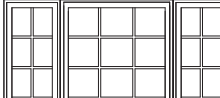
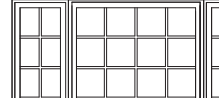
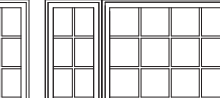
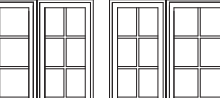
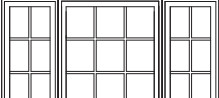
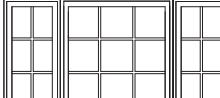
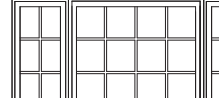
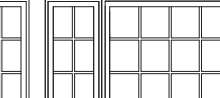
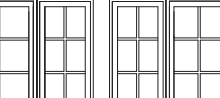
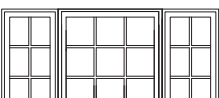
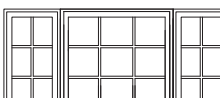
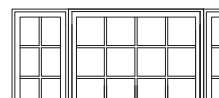
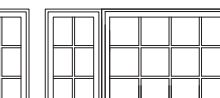
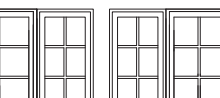
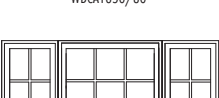

Unit Dimension

Rough Opening

Call Size

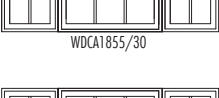
Heights

3' – 0"	3' – 0 15/16"	3–0
3' – 4 1/4"	3' – 5 7/8"	3–5
4' – 0 1/4"	4' – 1 7/8"	4–0
4' – 5"	4' – 5 15/16"	4–5
5' – 0"	5' – 0 15/16"	5–0
5' – 5"	5' – 5 15/16"	5–5
6' – 0"	6' – 0 15/16"	6–0

 WDCA1830/30	 WDCA1830/35	 WDCA1830/40	 WDCA1830/50	 WDCA1830/60
 WDCA1835/30	 WDCA1835/35	 WDCA1835/40	 WDCA1835/50	 WDCA1835/60
 WDCA1840/30	 WDCA1840/35	 WDCA1840/40	 WDCA1840/50	 WDCA1840/60
 WDCA1845/30	 WDCA1845/35	 WDCA1845/40	 WDCA1845/50	 WDCA1845/60
 WDCA1850/30	 WDCA1850/35	 WDCA1850/40	 WDCA1850/50	 WDCA1850/60
 WDCA1855/30	 WDCA1855/35	 WDCA1855/40	 WDCA1855/50	 WDCA1855/60
 WDCA1860/30	 WDCA1860/35	 WDCA1860/40	 WDCA1860/50	 WDCA1860/60

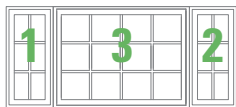

STYLE 2VB
(Shown Above)

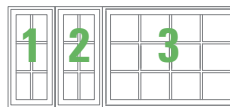

STYLE 2VL

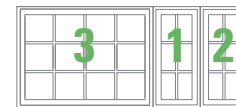

STYLE 2VR

Note: Viewed from exterior, Windows 1 and 2 are operating. Window 3 is stationary

		Widths			
		2' - 0 1/4"	4' - 0 1/2"	6' - 0 3/4"	8' - 1"
		2' - 1 1/4"	4' - 1 1/2"	6' - 1 3/4"	8' - 2"
		2-0	2-0 Twin	2-0 Triple	2-0 Quad
Heights	Unit Dimension	3' - 0"	3' - 0"	3' - 0"	3' - 0"
	Rough Opening	3' - 0 15/16"	3' - 0 15/16"	3' - 0 15/16"	3' - 0 15/16"
	Call Size	3-0	3-0	3-0	3-0
	WDCA2030	WDCA2030-2	WDCA2030-3	WDCA2030-4	
	3' - 4 1/2"	3' - 4 1/2"	3' - 4 1/2"	3' - 4 1/2"	
	Rough Opening	3' - 5 7/16"	3' - 5 7/16"	3' - 5 7/16"	3' - 5 7/16"
	Call Size	3-5	3-5	3-5	3-5
WDCA2035	WDCA2035-2	WDCA2035-3	WDCA2035-4		
4' - 0 1/2"	4' - 0 1/2"	4' - 0 1/2"	4' - 0 1/2"		
Rough Opening	4' - 1 7/16"	4' - 1 7/16"	4' - 1 7/16"	4' - 1 7/16"	
Call Size	4-0	4-0	4-0	4-0	
WDCA2040	WDCA2040-2	WDCA2040-3	WDCA2040-4		
4' - 5"	4' - 5"	4' - 5"	4' - 5"		
Rough Opening	4' - 5 9/16"	4' - 5 9/16"	4' - 5 9/16"	4' - 5 9/16"	
Call Size	4-5	4-5	4-5	4-5	
WDCA2045	WDCA2045-2	WDCA2045-3	WDCA2045-4		
5' - 0"	5' - 0"	5' - 0"	5' - 0"		
Rough Opening	5' - 0 15/16"	5' - 0 15/16"	5' - 0 15/16"	5' - 0 15/16"	
Call Size	5-0	5-0	5-0	5-0	
WDCA2050	WDCA2050-2	WDCA2050-3	WDCA2050-4		
5' - 5"	5' - 5"	5' - 5"	5' - 5"		
Rough Opening	5' - 5 15/16"	5' - 5 15/16"	5' - 5 15/16"	5' - 5 15/16"	
Call Size	5-5	5-5	5-5	5-5	
WDCA2055	WDCA2055-2	WDCA2055-3	WDCA2055-4		
6' - 0"	6' - 0"	6' - 0"	6' - 0"		
Rough Opening	6' - 0 15/16"	6' - 0 15/16"	6' - 0 15/16"	6' - 0 15/16"	
Call Size	6-0	6-0	6-0	6-0	
WDCA2060	WDCA2060-2	WDCA2060-3	WDCA2060-4		

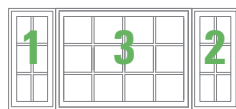
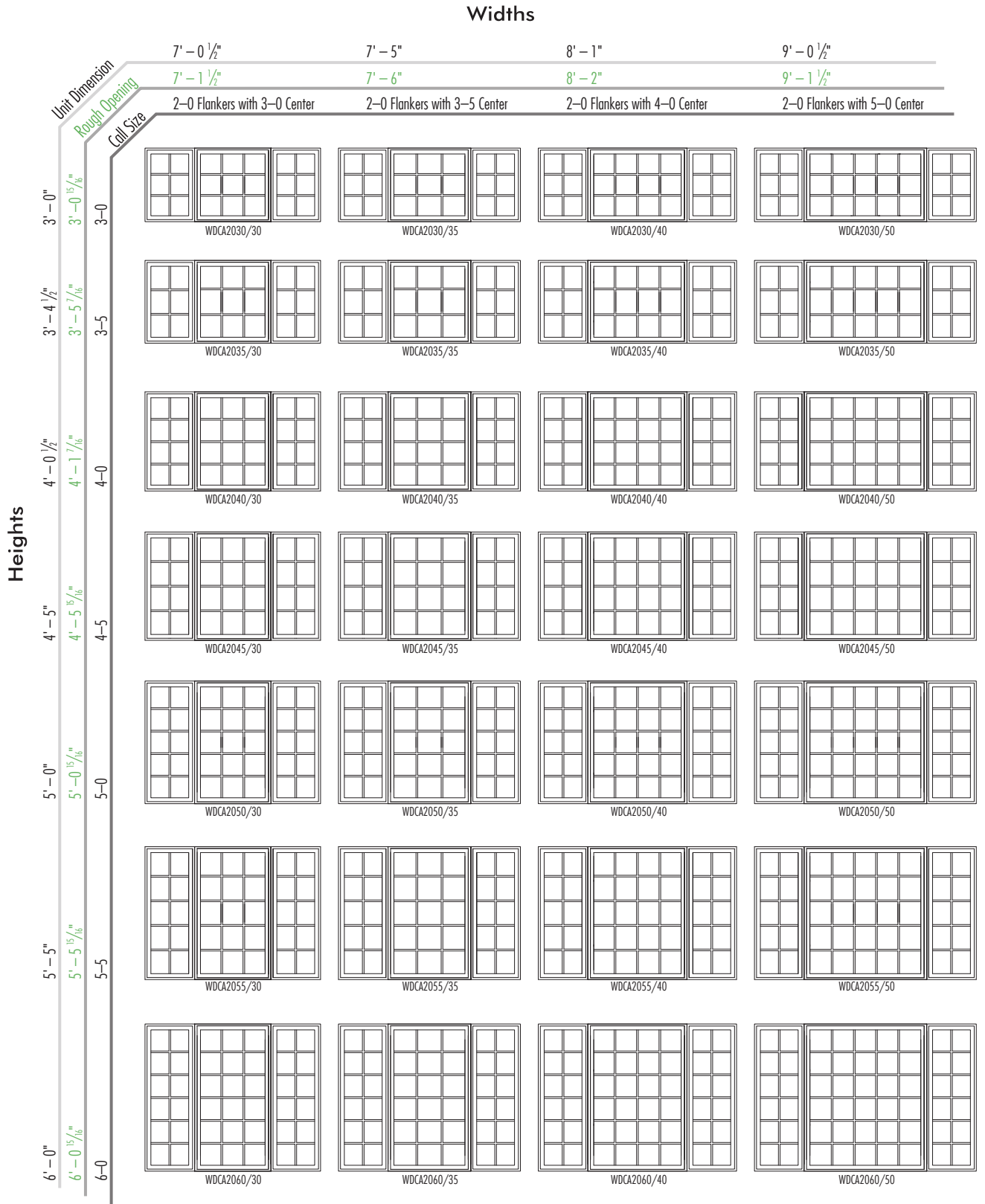

STYLE 2VB
(Shown Above)



STYLE 2VL

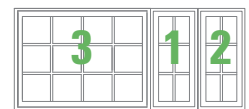

STYLE 2VR

Note: Viewed from exterior, Windows 1 and 2 are operating. Window 3 is stationary

Widths

2' - 4 1/4"	4' - 8 1/2"	7' - 0 3/4"	9' - 5"
2' - 5 1/4"	4' - 9 1/2"	7' - 1 3/4"	9' - 6"
2-4	2-4 Twin	2-4 Triple	2-4 Quad

Heights

3' - 0"	3' - 0 15/16"	3-0
3' - 4 1/2"	3' - 5 7/16"	3-5
4' - 0 1/2"	4' - 1 7/16"	4-0
4' - 5"	4' - 5 5/16"	4-5
5' - 0"	5' - 0 15/16"	5-0
5' - 5"	5' - 5 15/16"	5-5
6' - 0"	6' - 0 15/16"	6-0

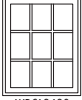
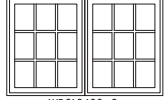
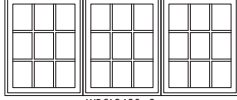
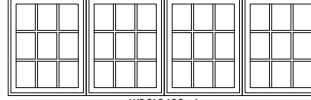
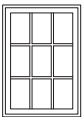
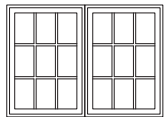
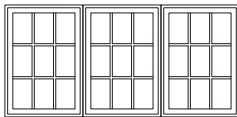
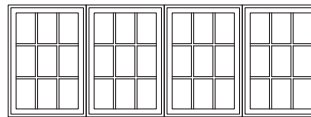
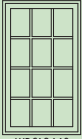
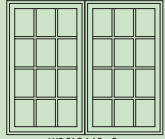
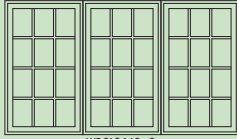
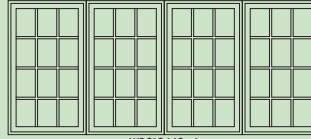
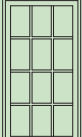
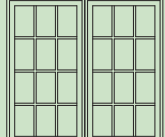
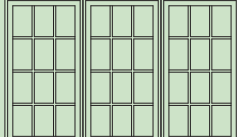
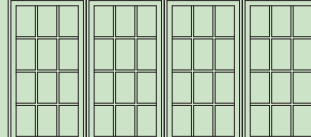
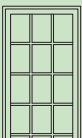
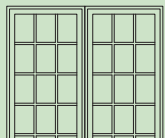
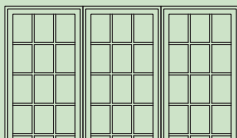
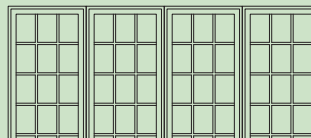
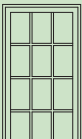
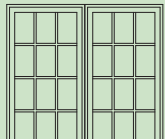
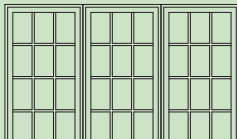
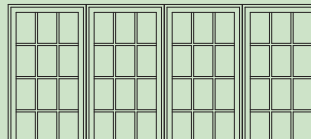
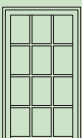
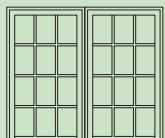
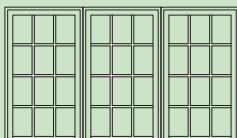
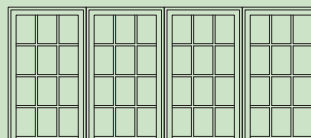
 WDCA2430	 WDCA2430-2	 WDCA2430-3	 WDCA2430-4
 WDCA2435	 WDCA2435-2	 WDCA2435-3	 WDCA2435-4
 WDCA2440	 WDCA2440-2	 WDCA2440-3	 WDCA2440-4
 WDCA2445	 WDCA2445-2	 WDCA2445-3	 WDCA2445-4
 WDCA2450	 WDCA2450-2	 WDCA2450-3	 WDCA2450-4
 WDCA2455	 WDCA2455-2	 WDCA2455-3	 WDCA2455-4
 WDCA2460	 WDCA2460-2	 WDCA2460-3	 WDCA2460-4

NOTE:

Shaded units satisfy IRC egress requirements. Check with your local code official to confirm egress requirements in your area.

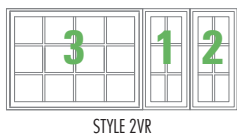
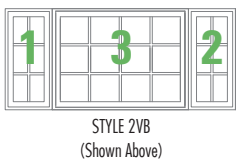
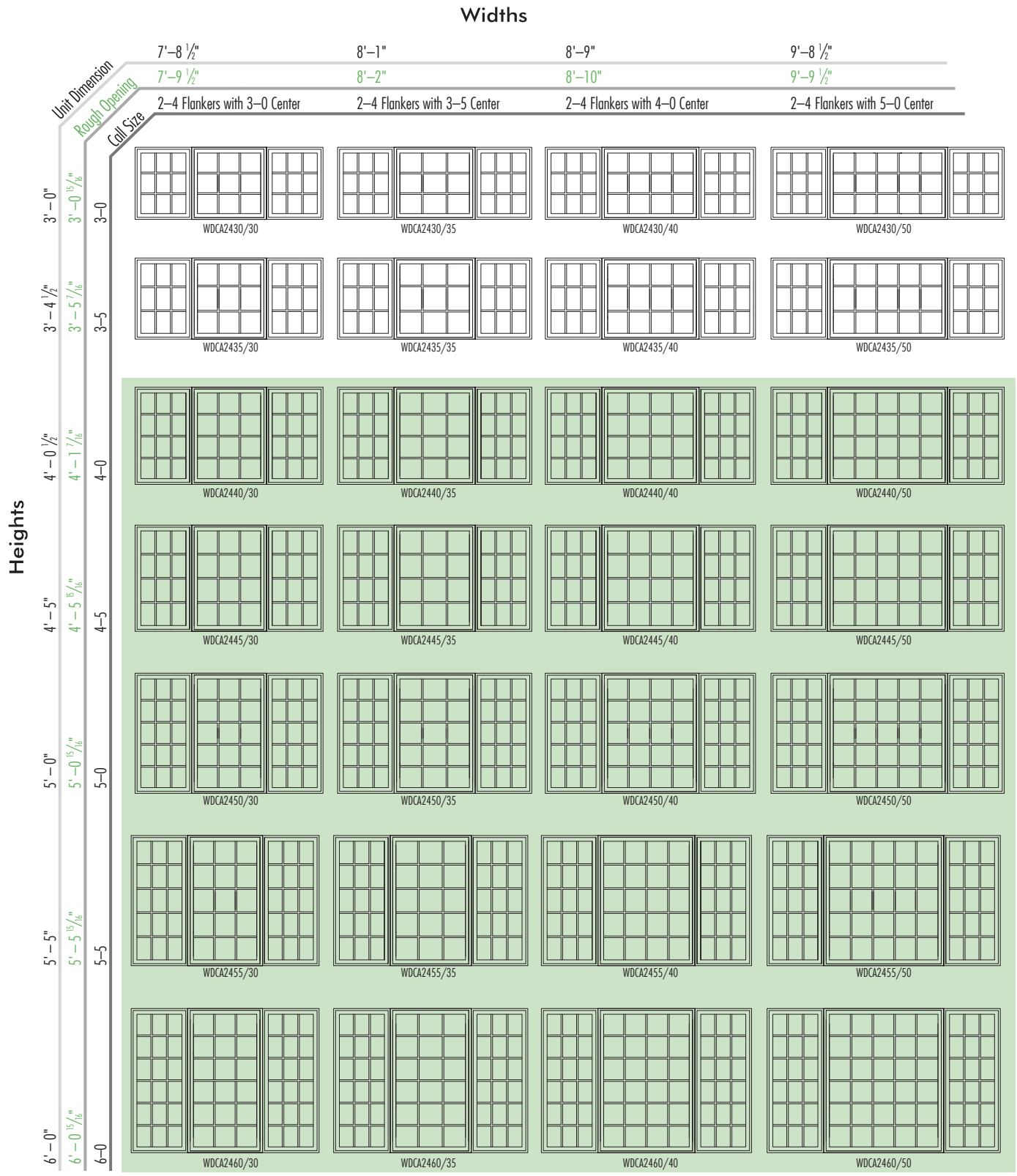





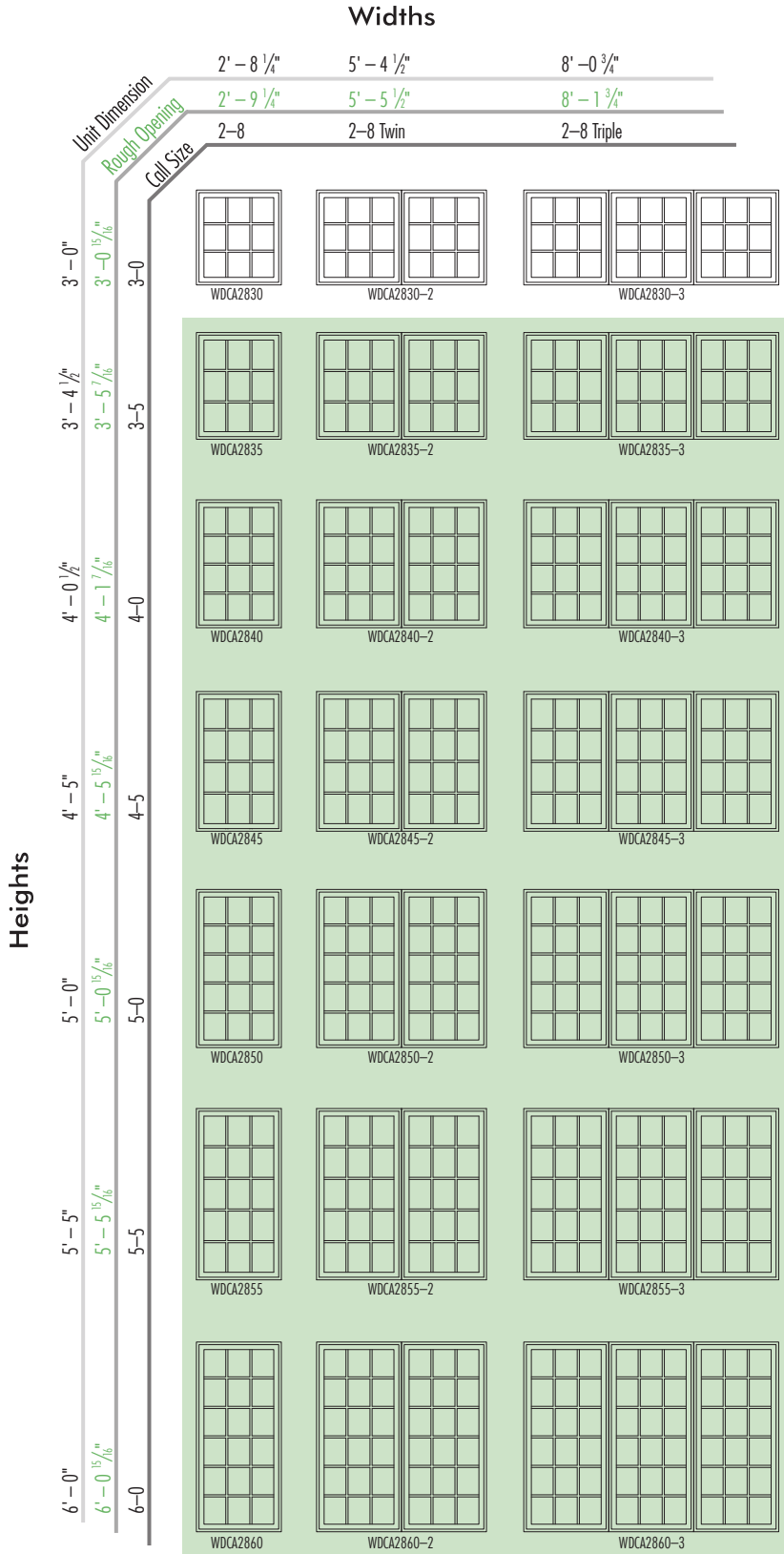



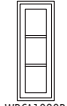
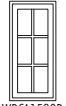
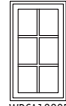
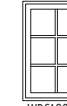

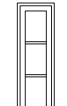
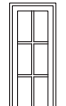

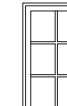

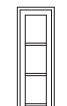
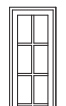

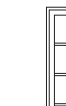

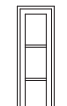
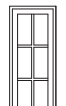

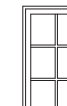

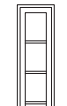
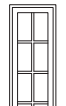



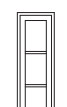
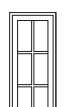



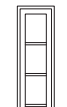
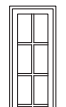

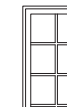

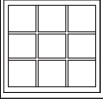
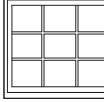
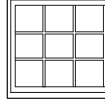
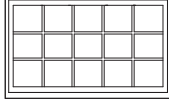
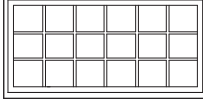
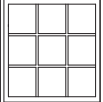
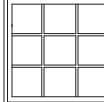

NOTE:
Shaded units satisfy IRC egress requirements. Check with your local code official to confirm egress requirements in your area.

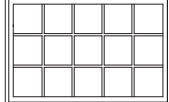
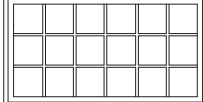
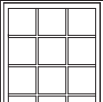
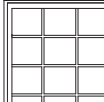
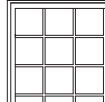
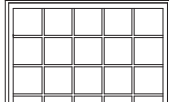
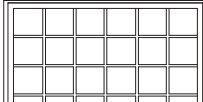
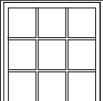
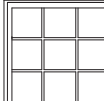
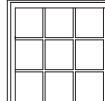
Note: Viewed from exterior, Windows 1 and 2 are operating. Window 3 is stationary

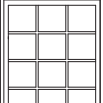
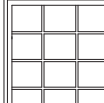
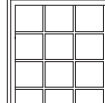

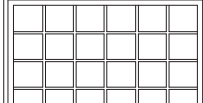
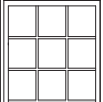
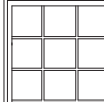
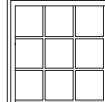
NOTE:
 Shaded units satisfy IRC egress requirements. Check with your local code official to confirm egress requirements in your area.

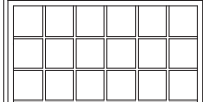
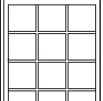
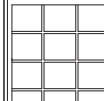
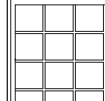
		Widths							
		1' - 1 3/8"	1' - 4 3/4"	1' - 8 1/4"	2' - 0 1/4"	2' - 4 1/4"	2' - 8 1/4"		
		1' - 2 3/8"	1' - 5 3/4"	1' - 9 1/4"	2' - 1 1/4"	2' - 5 1/4"	2' - 9 1/4"		
		1-0	1-5	1-8	2-0	2-4	2-8		
Heights	Unit Dimension	Rough Opening							
	Coil Size	Coil Size							
	3'-0"	3'-0 15/16"	3-0						
	3'-4 1/2"	3'-5 7/16"	3-5						
	4'-0 1/2"	4'-1 7/16"	4-0						
	4'-5"	4'-5 15/16"	4-5						
	5'-0"	5'-0 15/16"	5-0						
	5'-5"	5'-5 15/16"	5-5						
6'-0"	6'-0 15/16"	6-0							

		Widths				
		3' - 0"	3' - 4 1/2"	4' - 0 1/2"	5' - 0"	6' - 0"
		3' - 1"	3' - 5 1/2"	4' - 1 1/2"	5' - 1"	6' - 1"
		3-0	3-5	4-0	5-0	6-0
Heights	Unit Dimension	3' - 0"	3' - 4 1/2"	4' - 0 1/2"	5' - 0"	6' - 0"
	Rough Opening	3' - 0 15/16"	3' - 5 7/16"	4' - 1 7/16"	5' - 0 15/16"	6' - 0 15/16"
	Call Size	3-0	3-5	4-0	5-0	6-0
	3' - 0"	 WDC A3030P	 WDC A3530P	 WDC A4030P	 WDC A5030P	 WDC A6030P
	3' - 4 1/2"	 WDC A3035P	 WDC A3535P	 WDC A4035P	 WDC A5035P	 WDC A6035P
	4' - 0 1/2"	 WDC A3040P	 WDC A3540P	 WDC A4040P	 WDC A5040P	 WDC A6040P
	4' - 5"	 WDC A3045P	 WDC A3545P	 WDC A4045P	 WDC A5045P	 WDC A6045P
	5' - 0"	 WDC A3050P	 WDC A3550P	 WDC A4050P	 WDC A5050P	 WDC A6050P
5' - 5"	 WDC A3055P	 WDC A3555P	 WDC A4055P	 WDC A5055P	 WDC A6055P	
6' - 0"	 WDC A3060P	 WDC A3560P	 WDC A4060P	 WDC A5060P	 WDC A6060P	

Standard Colonial Grille Pattern Widths

Unit Dimension	Standard Colonial Grille Pattern Widths				
	1' - 4 3/4"	1' - 8 1/4"	2' - 0 1/4"	2' - 4 1/4"	
	1' - 5 3/4"	1' - 9 1/4"	2' - 1 1/4"	2' - 5 1/4"	
Rough Opening					
Call Size	1-5	1-8	2-0	2-4	
Heights Unit height dimension is listed first under individual windows Rough Opening height dimension is listed second under individual windows	3-0	 WDCA1530AH 3' - 2 13/16" 3' - 3 5/16"	 WDCA1830AH 3' - 3 3/8" 3' - 3 7/8"	 WDCA2030AH 3' - 4 1/8" 3' - 4 9/16"	 WDCA2430AH 3' - 4 3/4" 3' - 5 1/4"
	3-5	 WDCA1535AH 3' - 7 5/16" 3' - 7 9/16"	 WDCA1835AH 3' - 7 7/8" 3' - 8 3/8"	 WDCA2035AH 3' - 8 1/8" 3' - 9 1/8"	 WDCA2435AH 3' - 9 1/4" 3' - 9 3/4"
	4-0	 WDCA1540AH 4' - 3 3/16" 4' - 3 13/16"	 WDCA1840AH 4' - 3 7/8" 4' - 4 3/8"	 WDCA2040AH 4' - 4 9/16" 4' - 5 1/8"	 WDCA2440AH 4' - 5 1/4" 4' - 5 3/4"
	5-0	 WDCA1550AH 5' - 2 13/16" 5' - 3 3/16"	 WDCA1850AH 5' - 3 3/8" 5' - 3 7/8"	 WDCA2050AH 5' - 4 1/8" 5' - 4 9/16"	 WDCA2450AH 5' - 4 3/4" 5' - 5 1/4"
	6-0	 WDCA1560AH 6' - 2 13/16" 6' - 3 3/16"	 WDCA1860AH 6' - 3 3/8" 6' - 3 7/8"	 WDCA2060AH 6' - 4 1/8" 6' - 4 9/16"	 WDCA2460AH 6' - 4 3/4" 6' - 5 1/4"

Optional Renaissance Grille Pattern Widths

Unit Dimension	Optional Renaissance Grille Pattern Widths	
	2' - 4 1/4"	
	2' - 5 1/4"	
Rough Opening		
Call Size	2-4	
Heights Unit height dimension is listed first under individual windows Rough Opening height dimension is listed second under individual windows	3-0	 WDCA2430AH 3' - 4 3/4" 3' - 5 1/4"
	3-5	 WDCA2435AH 3' - 9 1/4" 3' - 9 3/4"
	4-0	 WDCA2440AH 4' - 5 1/4" 4' - 5 3/4"
	5-0	 WDCA2450AH 5' - 4 3/4" 5' - 5 1/4"
	6-0	 WDCA2460AH 6' - 4 3/4" 6' - 5 1/4"

Standard Colonial Grille Pattern Widths

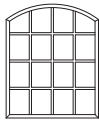
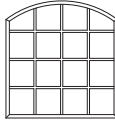
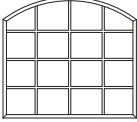
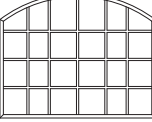
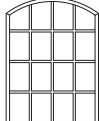
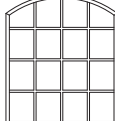
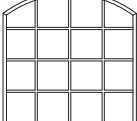
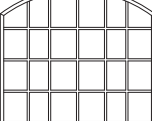
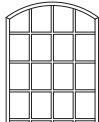
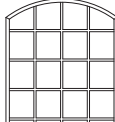
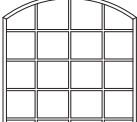
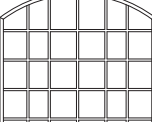
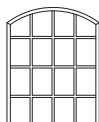
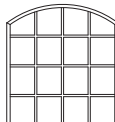
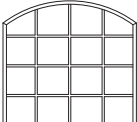
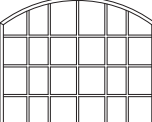
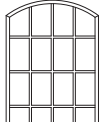
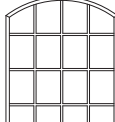
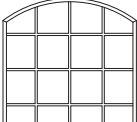
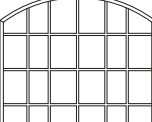
		2' - 9 1/2"	3' - 4 1/2"	4' - 0 1/2"	4' - 8 1/2"
		2' - 10 1/2"	3' - 5 1/2"	4' - 1 1/2"	4' - 9 1/2"
		1-5 Twin	1-8 Twin	2-0 Twin	2-4 Twin
Heights Unit height dimension is listed first under individual windows Rough Opening height dimension is listed second under individual windows	Unit Dimension Rough Opening Call Size	 WDCA1530-2AH 3'-5 9/16" 3'-6 1/8"	 WDCA1830-2AH 3'-6 3/4" 3'-7 1/8"	 WDCA2030-2AH 3'-8 1/8" 3'-8 3/8"	 WDCA2430-2AH 3'-9 7/16" 3'-9 15/16"
	3-0	 WDCA1535-2AH 3'-10 1/4" 3'-10 3/8"	 WDCA1835-2AH 3'-11 1/4" 3'-11 3/8"	 WDCA2035-2AH 4'-0 3/8" 4'-1 1/8"	 WDCA2435-2AH 4'-1 15/16" 4'-2 1/16"
	3-5	 WDCA1540-2AH 4'-6 1/8" 4'-6 3/8"	 WDCA1840-2AH 4'-7 1/4" 4'-7 3/8"	 WDCA2040-2AH 4'-8 5/8" 4'-9 1/8"	 WDCA2440-2AH 4'-9 15/16" 4'-10 7/16"
	4-0	 WDCA1550-2AH 5'-5 9/16" 5'-6 1/8"	 WDCA1850-2AH 5'-6 3/4" 5'-7 1/8"	 WDCA2050-2AH 5'-8 1/8" 5'-8 3/8"	 WDCA2450-2AH 5'-9 1/16" 5'-9 15/16"
	5-0	 WDCA1550-2AH 6'-5 9/16" 6'-6 1/8"	 WDCA1860-2AH 6'-6 3/4" 6'-7 1/8"	 WDCA2060-2AH 6'-8 1/8" 6'-8 3/8"	 WDCA2460-2AH 6'-9 7/16" 6'-9 15/16"
	6-0				

Optional Renaissance Grille Pattern Widths

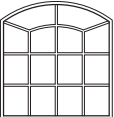
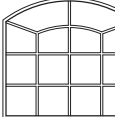
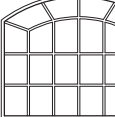
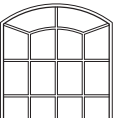
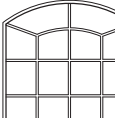
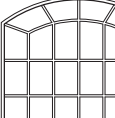
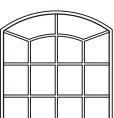
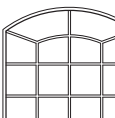
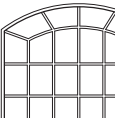
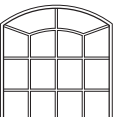
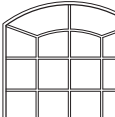
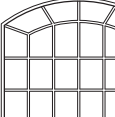
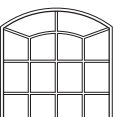
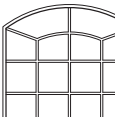
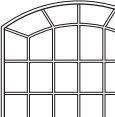
Unit Dimension Rough Opening Call Size	3' – 4 1/2"	4' – 0 1/2"	4' – 8 1/2"
	3' – 5 1/2"	4' – 1 1/2"	4' – 9 1/2"
	1-8 Twin	2-0 Twin	2-4 Twin
3-0	 WDCA1830-2AH 3' – 6 3/4" 3' – 7 1/4"	 WDCA2030-2AH 3' – 8 1/8" 3' – 8 5/8"	 WDCA2430-2AH 3' – 9 1/16" 3' – 9 15/16"
3-5	 WDCA1835-2AH 3' – 11 1/4" 3' – 11 3/4"	 WDCA2035-2AH 4' – 0 5/8" 4' – 1 1/8"	 WDCA2435-2AH 4' – 1 15/16" 4' – 2 1/16"
4-0	 WDCA1840-2AH 4' – 7 1/4" 4' – 7 3/4"	 WDCA2040-2AH 4' – 8 5/8" 4' – 9 1/8"	 WDCA2440-2AH 4' – 9 15/16" 4' – 10 1/16"
5-0	 WDCA1850-2AH 5' – 6 3/4" 5' – 7 1/4"	 WDCA2050-2AH 5' – 8 1/8" 5' – 8 5/8"	 WDCA2450-2AH 5' – 9 1/16" 5' – 9 15/16"
6-0	 WDCA1860-2AH 6' – 6 3/4" 6' – 7 1/4"	 WDCA2060-2AH 6' – 8 1/4" 6' – 8 5/8"	 WDCA2460-2AH 6' – 9 1/16" 6' – 9 15/16"

Heights

Unit height dimension is listed first under individual windows

Rough Opening height dimension is listed second under individual windows

Standard Colonial Grille Pattern Widths

Unit Dimension Rough Opening Grid Size	Standard Colonial Grille Pattern Widths									
	1' - 4 3/4"	1' - 8 1/4"	2' - 0 1/4"	2' - 4 1/4"	2' - 8 1/4"	3' - 0"	3' - 4 1/2"	4' - 0 1/2"	5' - 0"	6' - 0"
	1' - 5 3/4"	1' - 9 1/4"	2' - 1 1/4"	2' - 5 1/4"	2' - 9 1/4"	3' - 1"	3' - 5 1/2"	4' - 1 1/2"	5' - 1"	6' - 1"
Grid Size	1-5	1-8	2-0	2-4	2-8	3-0	3-5	4-0	5-0	6-0
0-6	 WDCA1506AHTN 0' - 10 3/16" 0' - 10 11/16"	 WDCA1806AHTN 0' - 10 3/4" 0' - 11 1/4"	 WDCA2006AHTN 0' - 11 1/16" 0' - 11 15/16"	 WDCA2406AHTN 1' - 0 1/8" 1' - 0 3/8"	 WDCA2806AHTN 1' - 0 3/4" 1' - 1 1/4"	 WDCA3006AHTN 1' - 1 3/8" 1' - 1 7/8"	 WDCA3506AHTN 1' - 2 1/8" 1' - 2 5/8"	 WDCA4006AHTN 1' - 3 1/2" 1' - 4"	 WDCA5006AHTN 1' - 5 3/8" 1' - 5 7/8"	 WDCA6006AHTN 1' - 7 3/8" 1' - 7 7/8"
0-10	 WDCA15010AHTN 1' - 2 3/16" 1' - 2 11/16"	 WDCA18010AHTN 1' - 2 3/4" 1' - 3 1/4"	 WDCA20010AHTN 1' - 3 7/16" 1' - 3 15/16"	 WDCA24010AHTN 1' - 4 1/8" 1' - 4 5/8"	 WDCA28010AHTN 1' - 4 3/4" 1' - 5 1/4"	 WDCA30010AHTN 1' - 5 3/8" 1' - 5 7/8"	 WDCA35010AHTN 1' - 6 1/8" 1' - 6 5/8"	 WDCA40010AHTN 1' - 7 1/2" 1' - 8"	 WDCA50010AHTN 1' - 9 3/8" 1' - 9 7/8"	 WDCA60010AHTN 1' - 11 3/8" 1' - 11 7/8"
1-0	 WDCA1510AHTN 1' - 4 3/16" 1' - 4 11/16"	 WDCA1810AHTN 1' - 4 3/4" 1' - 5 1/4"	 WDCA2010AHTN 1' - 5 7/16" 1' - 5 15/16"	 WDCA2410AHTN 1' - 6 1/8" 1' - 6 5/8"	 WDCA2810AHTN 1' - 6 3/4" 1' - 7 1/4"	 WDCA3010AHTN 1' - 7 3/8" 1' - 7 7/8"	 WDCA3510AHTN 1' - 8 1/8" 1' - 8 5/8"	 WDCA4010AHTN 1' - 9 1/2" 1' - 10"	 WDCA5010AHTN 1' - 11 3/8" 1' - 11 7/8"	 WDCA6010AHTN 2' - 1 3/8" 2' - 1 7/8"
1-2	 WDCA1512AHTN 1' - 6 3/16" 1' - 6 11/16"	 WDCA1812AHTN 1' - 6 3/4" 1' - 7 1/4"	 WDCA2012AHTN 1' - 7 7/16" 1' - 7 15/16"	 WDCA2412AHTN 1' - 8 1/8" 1' - 8 5/8"	 WDCA2812AHTN 1' - 8 3/4" 1' - 9 1/4"	 WDCA3012AHTN 1' - 9 3/8" 1' - 9 7/8"	 WDCA3512AHTN 1' - 10 1/8" 1' - 10 5/8"	 WDCA4012AHTN 1' - 11 1/2" 2' - 0"	 WDCA5012AHTN 2' - 1 3/8" 2' - 1 7/8"	 WDCA6012AHTN 2' - 3 3/8" 2' - 3 7/8"
2-0	 WDCA1520AHTN 2' - 4 7/16" 2' - 4 15/16"	 WDCA1820AHTN 2' - 5" 2' - 5 1/2"	 WDCA2020AHTN 2' - 5 11/16" 2' - 6 3/16"	 WDCA2420AHTN 2' - 6 3/8" 2' - 6 7/8"	 WDCA2820AHTN 2' - 7" 2' - 7 1/2"	 WDCA3020AHTN 2' - 7 5/8" 2' - 8 1/8"	 WDCA3520AHTN 2' - 8 3/8" 2' - 8 7/8"	 WDCA4020AHTN 2' - 9 3/4" 2' - 10 1/4"	 WDCA5020AHTN 2' - 11 3/8" 3' - 0 3/8"	 WDCA6020AHTN 3' - 1 5/8" 3' - 2 1/8"

Heights

Unit height dimension is listed first under individual windows

Rough opening height dimension is listed second under individual windows

Optional Renaissance Grille Pattern Widths

Heights	Optional Renaissance Grille Pattern Widths						
	2' - 4 1/4"	2' - 8 1/4"	3' - 0"	3' - 4 1/2"	4' - 0 1/2"	5' - 0"	6' - 0"
	2' - 5 1/4"	2' - 9 1/4"	3' - 1"	3' - 5 1/2"	4' - 1 1/2"	5' - 1"	6' - 1"
Unit Dimension	2-4	2-8	3-0	3-5	4-0	5-0	6-0
Rough Opening							
Call Size							
0-6	 WDCA2406AHTN 1' - 0 1/8" 1' - 0 3/8"	 WDCA2806AHTN 1' - 0 3/4" 1' - 1 1/4"	 WDCA3006AHTN 1' - 1 3/8" 1' - 1 7/8"	 WDCA3506AHTN 1' - 2 1/8" 1' - 2 5/8"	 WDCA4006AHTN 1' - 3 1/2" 1' - 4"	 WDCA5006AHTN 1' - 5 3/8" 1' - 5 7/8"	 WDCA6006AHTN 1' - 7 3/8" 1' - 7 7/8"
0-10	 WDCA24010AHTN 1' - 4 1/8" 1' - 4 5/8"	 WDCA28010AHTN 1' - 4 3/4" 1' - 5 1/4"	 WDCA30010AHTN 1' - 5 3/8" 1' - 5 7/8"	 WDCA35010AHTN 1' - 6 1/8" 1' - 6 5/8"	 WDCA40010AHTN 1' - 7 1/2" 1' - 8"	 WDCA50010AHTN 1' - 9 3/8" 1' - 9 7/8"	 WDCA60010AHTN 1' - 11 3/8" 1' - 11 7/8"
1-0	 WDCA2410AHTN 1' - 6 1/8" 1' - 6 5/8"	 WDCA2810AHTN 1' - 6 3/4" 1' - 7 1/4"	 WDCA3010AHTN 1' - 7 3/8" 1' - 7 7/8"	 WDCA3510AHTN 1' - 8 1/8" 1' - 8 5/8"	 WDCA4010AHTN 1' - 9 1/2" 1' - 10"	 WDCA5010AHTN 1' - 11 3/8" 1' - 11 7/8"	 WDCA6010AHTN 2' - 1 3/8" 2' - 1 7/8"
1-2	 WDCA2412AHTN 1' - 8 1/8" 1' - 8 5/8"	 WDCA2812AHTN 1' - 8 3/4" 1' - 9 1/4"	 WDCA3012AHTN 1' - 9 3/8" 1' - 9 7/8"	 WDCA3512AHTN 1' - 10 1/8" 1' - 10 5/8"	 WDCA4012AHTN 1' - 11 1/2" 2' - 0"	 WDCA5012AHTN 2' - 1 3/8" 2' - 1 7/8"	 WDCA6012AHTN 2' - 3 3/8" 2' - 3 7/8"
2-0	 WDCA2420AHTN 2' - 6 3/8" 2' - 6 7/8"	 WDCA2820AHTN 2' - 7" 2' - 7 1/2"	 WDCA3020AHTN 2' - 7 5/8" 2' - 8 1/8"	 WDCA3520AHTN 2' - 8 3/8" 2' - 8 7/8"	 WDCA4020AHTN 2' - 9 3/4" 2' - 10 1/4"	 WDCA5020AHTN 2' - 11 3/8" 3' - 0 3/8"	 WDCA6020AHTN 3' - 1 3/8" 3' - 2 3/8"

Standard Colonial Grille Pattern Widths

Optional Renaissance Grille Pattern Widths

Heights

Heights

Unit Dimension
Rough Opening
Call Size

Unit Dimension	2' - 9 1/2"	3' - 4 1/2"	4' - 0 1/2"	4' - 8 1/2"
0-6	WDCA1506-2AHTN 1' - 0 15/16" 1' - 1 1/8"	WDCA1806-2AHTN 1' - 2 1/8" 1' - 2 5/8"	WDCA2006-2AHTN 1' - 3 1/2" 1' - 4"	WDCA2406-2AHTN 1' - 4 13/16" 1' - 5 3/8"
0-10	WDCA15010-2AHTN 1' - 4 15/16" 1' - 5 3/8"	WDCA18010-2AHTN 1' - 6 1/8" 1' - 6 5/8"	WDCA20010-2AHTN 1' - 7 1/2" 1' - 8"	WDCA24010-2AHTN 1' - 8 13/16" 1' - 9 3/8"
1-0	WDCA1510-2AHTN 1' - 6 15/16" 1' - 7 1/8"	WDCA1810-2AHTN 1' - 8 1/8" 1' - 8 5/8"	WDCA2010-2AHTN 1' - 9 1/2" 1' - 10"	WDCA2410-2AHTN 1' - 10 13/16" 1' - 11 3/8"
1-2	WDCA1512-2AHTN 1' - 8 15/16" 1' - 9 1/8"	WDCA1812-2AHTN 1' - 10 1/8" 1' - 10 5/8"	WDCA2012-2AHTN 1' - 11 1/2" 2' - 0"	WDCA2412-2AHTN 2' - 0 13/16" 2' - 1 3/8"
2-0	WDCA1520-2AHTN 2' - 7 3/16" 2' - 7 11/16"	WDCA1820-2AHTN 2' - 8 3/8" 2' - 8 7/8"	WDCA2020-2AHTN 2' - 9 3/4" 2' - 10 1/4"	WDCA2420-2AHTN 2' - 11 1/16" 2' - 11 5/8"

Unit height dimension is listed first under individual windows
Rough Opening height dimension is listed second under individual windows

Unit Dimension
Rough Opening
Call Size

Unit Dimension	3' - 4 1/2"	4' - 0 1/2"	4' - 8 1/2"
0-6	WDCA1806-2AHTN 1' - 2 1/8" 1' - 2 5/8"	WDCA2006-2AHTN 1' - 3 1/2" 1' - 4"	WDCA2406-2AHTN 1' - 4 13/16" 1' - 5 3/8"
0-10	WDCA18010-2AHTN 1' - 6 1/8" 1' - 6 5/8"	WDCA20010-2AHTN 1' - 7 1/2" 1' - 8"	WDCA24010-2AHTN 1' - 8 13/16" 1' - 9 3/8"
1-0	WDCA1810-2AHTN 1' - 8 1/8" 1' - 8 5/8"	WDCA2010-2AHTN 1' - 9 1/2" 1' - 10"	WDCA2410-2AHTN 1' - 10 13/16" 1' - 11 3/8"
1-2	WDCA1812-2AHTN 1' - 10 1/8" 1' - 10 5/8"	WDCA2012-2AHTN 1' - 11 1/2" 2' - 0"	WDCA2412-2AHTN 2' - 0 13/16" 2' - 1 3/8"
2-0	WDCA1820-2AHTN 2' - 8 3/8" 2' - 8 7/8"	WDCA2020-2AHTN 2' - 9 3/4" 2' - 10 1/4"	WDCA2420-2AHTN 2' - 11 1/16" 2' - 11 5/8"

Unit height dimension is listed first under individual windows
Rough Opening height dimension is listed second under individual windows

Picture Widths

Unit Dimension
Rough Opening
Call Size

Unit Dimension	3'-0"	3'-4 1/2"	4'-0 1/2"	5'-0"	6'-0"
0-10	WDCA30010-PTN	WDCA35010-PTN	WDCA40010-PTN	WDCA50010-PTN	WDCA60010-PTN
1-0	WDCA3010-PTN	WDCA3510-PTN	WDCA4010-PTN	WDCA5010-PTN	WDCA6010-PTN
1-2	WDCA3012-PTN	WDCA3512-PTN	WDCA4012-PTN	WDCA5012-PTN	WDCA6012-PTN
2-0	WDCA3020-PTN	WDCA3520-PTN	WDCA4020-PTN	WDCA5020-PTN	WDCA6020-PTN
2-4	WDCA3024-PTN	WDCA3524-PTN	WDCA4024-PTN	WDCA5024-PTN	WDCA6024-PTN

Unit height dimension is listed first under individual windows
Rough Opening height dimension is listed second under individual windows

Single Widths

Heights	Unit Dimension				
	1'-4 3/4"	1'-8 1/4"	2'-0 1/4"	2'-4 1/4"	2'-8 1/4"
	1'-5 3/4"	1'-9 1/4"	2'-1 1/4"	2'-5 1/4"	2'-9 1/4"
	1-5	1-8	2-0	2-4	2-8
0-11 3/8"					
1-1 3/8"					
1-3 3/8"					
2-1 3/8"					
2-5 5/8"					

Twin Widths

Heights	Unit Dimension				
	2'-9 1/2"	3'-4 1/2"	4'-0 1/2"	4'-8 1/2"	5'-4 1/2"
	2'-10 1/2"	3'-5 1/2"	4'-1 1/2"	4'-9 1/2"	5'-5 1/2"
	1-5 Twin	1-8 Twin	2-0 Twin	2-4 Twin	2-8 Twin
0-11 3/8"					
1-1 3/8"					
1-3 3/8"					
2-1 3/8"					
2-5 5/8"					

200 Casement – Circle Head & Quarter Circle Units

MW PRO SERIES 400, 300, 200

		Widths			
Heights	Unit Dimension	1' - 8 1/4"	2' - 0 1/4"	2' - 4 1/4"	2' - 8 1/4"
	Rough Opening	1' - 9 1/4"	2' - 1 1/4"	2' - 5 1/4"	2' - 9 1/4"
	Call Size	1-8	2-0	2-4	2-8
		WDCA18CH 0' - 11 3/8" 0' - 11 1/8"	WDCA20CH 1' - 1 3/8" 1' - 1 1/8"	WDCA24CH 1' - 3 3/8" 1' - 3 1/8"	WDCA28CH 1' - 5 3/8" 1' - 5 1/8"
Grille Options (See chart on this page)					
		CO1, CG2, COL	CO1, CG2, COL	CO3, CG3, COL	CO3, CG3, COL

		Widths			
Heights	Unit Dimension	1' - 8 1/4"	2' - 0 1/4"	2' - 4 1/4"	2' - 8 1/4"
	Rough Opening	1' - 9 1/4"	2' - 1 1/4"	2' - 5 1/4"	2' - 9 1/4"
	Call Size	1-8	2-0	2-4	2-8
		WDCA18QC 1' - 9 5/8" 1' - 10 1/8"	WDCA20QC 2' - 1 5/8" 2' - 2 1/8"	WDCA24QC 2' - 5 5/8" 2' - 6 1/8"	WDCA28QC 2' - 9 5/8" 2' - 10 1/8"
Grille Options (See chart on this page)					
		Q01, Q02, Q03, Q04, Q05, COL	Q01, Q02, Q03, Q04, Q05, COL	Q01, Q02, Q03, Q04, Q05, Q07, Q08, COL	Q01, Q02, Q03, Q04, Q05, Q07, Q08, COL





		Widths				
Heights	Unit Dimension	2' - 9 1/2"	3' - 4 1/2"	4' - 0 1/2"	4' - 8 1/2"	5' - 4 1/2"
	Rough Opening	2' - 10 1/2"	3' - 5 1/2"	4' - 1 1/2"	4' - 9 1/2"	5' - 5 1/2"
	Call Size	1-5 Twin	1-8 Twin	2-0 Twin	2-4 Twin	2-8 Twin
		WDCA15-2CH 1' - 6" 1' - 6 1/2"	WDCA18-2CH 1' - 9 1/2" 1' - 10"	WDCA20-2CH 2' - 1 1/2" 2' - 2"	WDCA24-2CH 2' - 5 1/2" 2' - 6"	WDCA28-2CH 2' - 9 1/2" 2' - 10"
Grille Options (See chart on this page)						
		CO1, CO2, CO3, CO4, CO5, CO6, CO7, CG2, CG3, CG4, COL	CO1, CO2, CO3, CO4, CO5, CO6, CO7, CG2, CG3, CG4, COL	CO1, CO2, CO3, CO4, CO5, CO6, CO7, CG2, CG3, CG4, COL	CO1, CO2, CO3, CO4, CO5, CO6, CO7, CO8, CO9, C10, C11, C12, CG2, CG3, CG4, CG5, CG6, COL	CO1, CO2, CO3, CO4, CO5, CO6, CO7, CO8, CO9, C10, C11, C12, CG2, CG3, CG4, CG5, CG6, COL



		Widths		
Heights	Unit Dimension	4' - 2 1/4"	5' - 0 3/4"	6' - 0 3/4"
	Rough Opening	4' - 3 3/4"	5' - 1 3/4"	6' - 1 3/4"
	Call Size	1-5 Triple	1-8 Triple	2-0 Triple
		WDCA15-3CH 2' - 2 3/8" 2' - 2 7/8"	WDCA18-3CH 2' - 7 3/8" 2' - 8 1/8"	WDCA20-3CH 3' - 1 3/8" 3' - 2 1/8"
Grille Options (See chart on this page)				
		CO1, CO2, CO3, CO4, CO5, CO6, CO7, CG2, CG3, CG4, CG5, CG6, COL	CO1, CO2, CO3, CO4, CO5, CO6, CO7, CO8, CO9, C10, C11, C12, CG2, CG3, CG5, CG6, COL	CO1, CO2, CO3, CO4, CO5, CO6, CO7, CO8, CO9, C10, C11, C12, CG2, CG3, CG5, CG6, COL





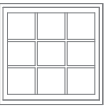
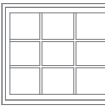
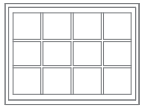
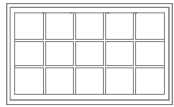
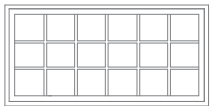

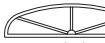
Optional Grille Patterns

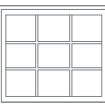
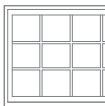
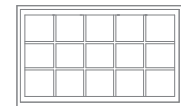
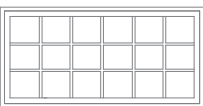
	C01		CG2
	C02		CG3
	C03		CG4
	C04		CG5
	C05		CG6
	C06		CG7
	C07		CG8
	C08		CG9
	C09		COL
	C10		Q01
	C11		Q02
	C12		Q03
	C13		Q04
	C14		Q05
	C15		Q07
	C16		Q08
	C17		Q08
	C18		Q10

Use order code to specify pattern

Heights	Widths				
	3' – 0"	3' – 4 1/2"	4' – 0 1/2"	5' – 0"	6' – 0"
	3' – 1"	3' – 5 1/2"	4' – 1 1/2"	5' – 1"	6' – 1"
	3-0 Picture	3-5 Picture	4-0 Picture	5-0 Picture	6-0 Picture
					
	WDCA30PCH 1' – 7 1/4" 1' – 7 3/4"	WDCA35PCH 1' – 9 1/2" 1' – 10"	WDCA40PCH 2' – 1 1/2" 2' – 2"	WDCA50PCH 2' – 7 1/4" 2' – 7 3/4"	WDCA60PCH 3' – 1 1/4" 3' – 1 3/4"
Grille Options (See chart on opposite page)					
	C03, CG3, COL	C03, CG3, COL	C01, C02, C03, C04, C05, C06, C07, CG2, CG3, CG4, COL	C03, C04, C08, C09, CG3, CG5, COL	C01, C02, C03, C04, C05, C06, C07, C08, C09, C010, C011, C012, CG2, CG3, CG4, CG5, CG6, COL

Heights	Widths			
	3' – 4 1/2"	4' – 0 1/2"	5' – 0"	6' – 0"
	3' – 5 1/2"	4' – 1 1/2"	5' – 1"	6' – 1"
	3-5 Picture	4-0 Picture	5-0 Picture	6-0 Picture
				
	WDCA35PEL 0' – 10 7/8" 0' – 11 3/8"	WDCA40PEL 1' – 0 1/8" 1' – 0 3/8"	WDCA50PEL 1' – 2 1/2" 1' – 3"	WDCA60PEL 1' – 5 1/16" 1' – 5 5/16"
Grille Options (See chart on opposite page)				
	C03, CG3, COL	C01, CG2, CG3, CG4, COL	C03, C04, CG3, CG5, COL	C01, C02, C03, C04, C05, C06, C07, CG2, CG3, CG4, CG5, CG6, COL

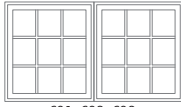
Heights	Widths			
	3' – 4 1/2"	4' – 0 1/2"	4' – 8 1/2"	5' – 4 1/2"
	3' – 5 1/2"	4' – 1 1/2"	4' – 9 1/2"	5' – 5 1/2"
	1-8 Twin	2-0 Twin	2-4 Twin	2-8 Twin
				
	WDCA18-2EL 0' – 10 7/8" 0' – 11 3/8"	WDCA20-2EL 1' – 0 1/8" 1' – 0 3/8"	WDCA24-2EL 1' – 1 13/16" 1' – 2 3/16"	WDCA28-2EL 1' – 3 1/2" 1' – 4"
Grille Options (See chart on opposite page)				
	C01, C02, C03, C04, C05, C06, C07, CG2, CG3, CG4, COL	C01, C02, C03, C04, C05, C06, C07, CG2, CG3, CG4, COL	C01, C02, C03, C04, C05, C06, C07, CG2, CG3, CG4, CG5, CG6, COL	C01, C02, C03, C04, C05, C06, C07, CG2, CG3, CG4, CG5, CG6, COL

Standard Colonial Grille Pattern Widths

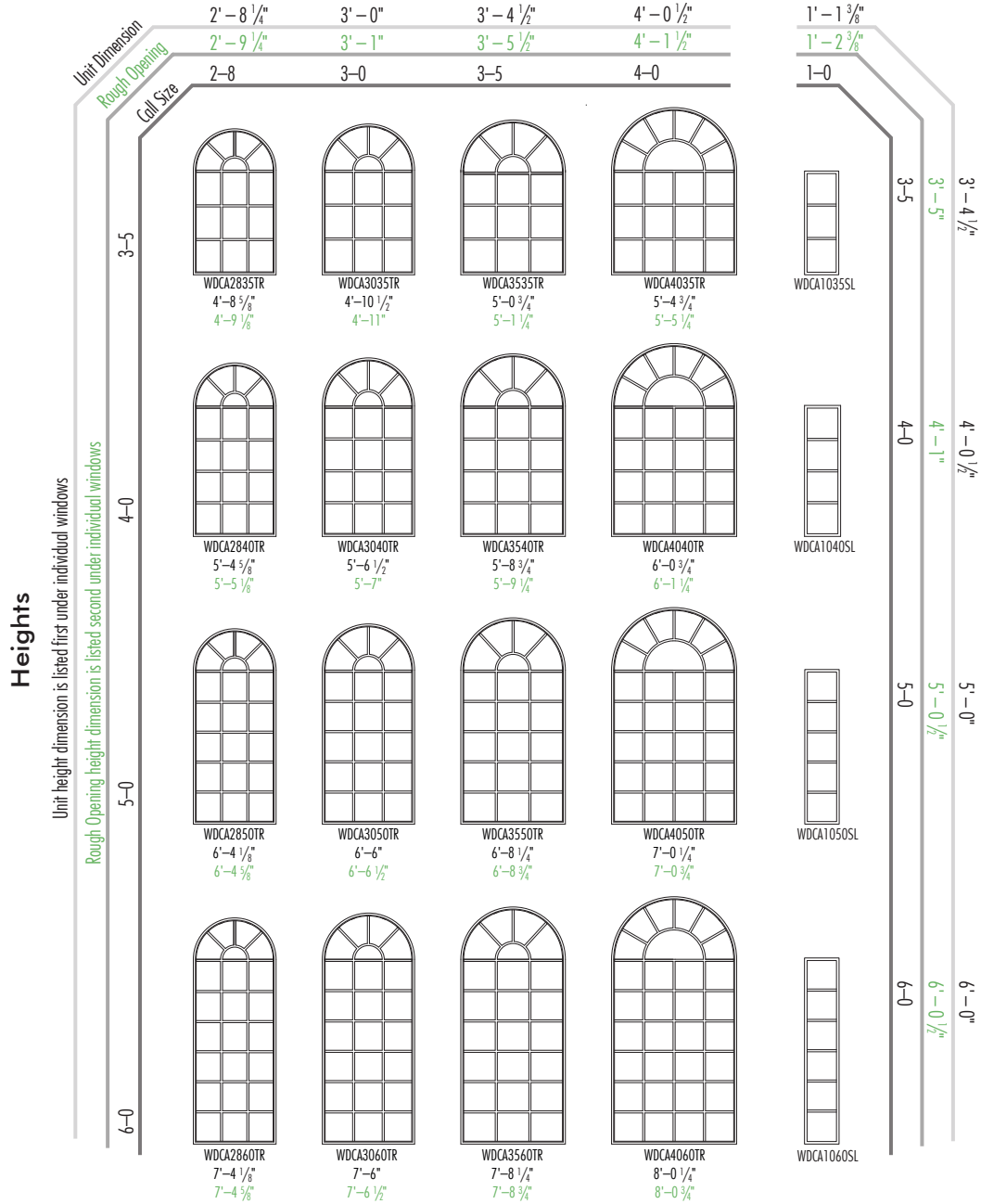

Optional Gothic Grille Pattern Widths

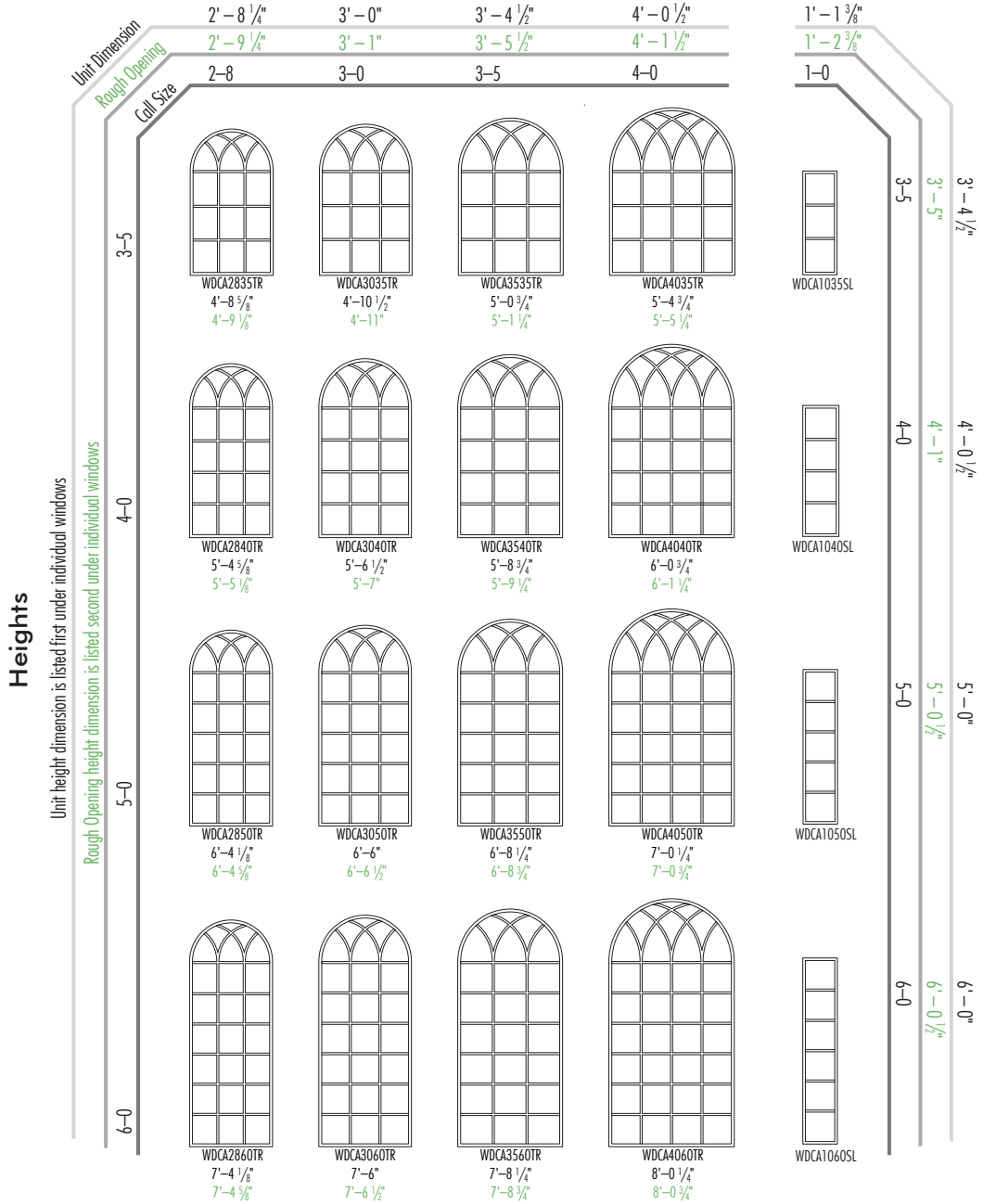

200 Casement – Actual Unit Dimensions

MW PRO SERIES 400, 300, 200

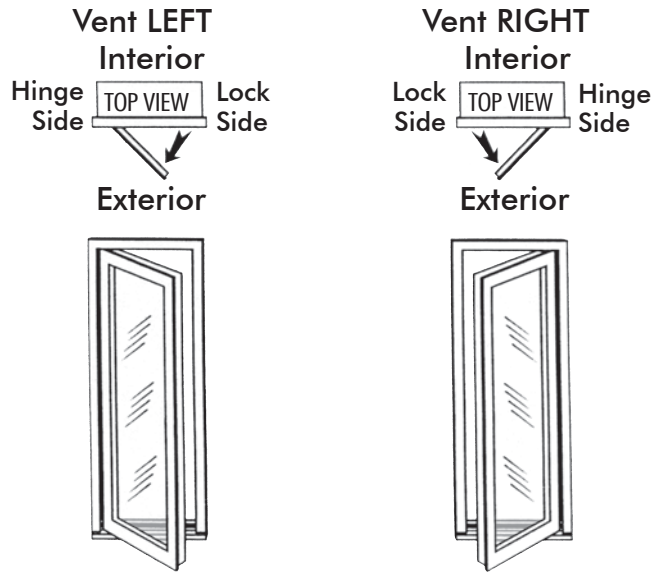
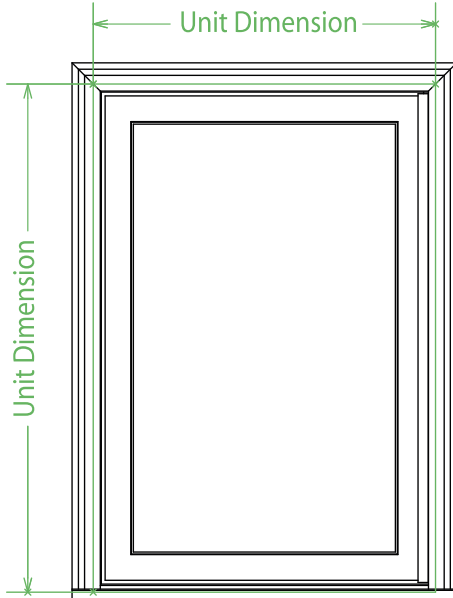

To calculate unit dimension on multiple units, add actual unit dimensions together.

Operating Units, WIDTH

CALL SIZE (WIDTH)	1-5	1-8	2-0	2-4	2-8
SINGLE	16 ³ / ₄	20 ¹ / ₄	24 ¹ / ₄	28 ¹ / ₄	32 ¹ / ₄
TWIN	33 ¹ / ₂	40 ¹ / ₂	48 ¹ / ₂	56 ¹ / ₂	64 ¹ / ₂
TRIPLE	50 ¹ / ₄	60 ³ / ₄	72 ³ / ₄	84 ³ / ₄	96 ³ / ₄
FOUR WIDE	67	81	97	113	N/A
FIVE WIDE	83 ³ / ₄	101 ¹ / ₄	N/A	N/A	N/A

Operating & Stationary Units, HEIGHT

CALL SIZE (HEIGHT)	HEIGHT IN INCHES
3-0	36
3-5	40 ¹ / ₂
4-0	48 ¹ / ₂
4-5	53
5-0	60
5-5	65
6-0	72

Stationary Units, WIDTH

CALL SIZE (WIDTH)	1-0	1-5	1-8	2-0	2-4	2-8
SINGLE	13 ³ / ₈	16 ³ / ₄	20 ¹ / ₄	24 ¹ / ₄	28 ¹ / ₄	32 ¹ / ₄
TWIN	26 ³ / ₄	33 ¹ / ₂	40 ¹ / ₂	48 ¹ / ₂	56 ¹ / ₂	64 ¹ / ₂
TRIPLE	40 ¹ / ₈	50 ¹ / ₄	60 ³ / ₄	72 ³ / ₄	84 ³ / ₄	96 ³ / ₄

Transom Units, HEIGHT

CALL SIZE (HEIGHT)	HEIGHT IN INCHES
0-10	11 ³ / ₈
1-0	13 ³ / ₈
1-2	15 ³ / ₈
2-0	25 ⁵ / ₈
2-4	29 ⁵ / ₈

Stationary Units, WIDTH

CALL SIZE (WIDTH)	3-0	3-5	4-0	5-0	6-0
SINGLE	36	40 ¹ / ₂	48 ¹ / ₂	60	72
TWIN	72	81	97	N/A	N/A
TRIPLE	108	N/A	N/A	N/A	N/A

Operating Units

Call Size	Clear Opening Width	Clear Opening Height	Clear Opening S.F.	Daylight Opening S.F.
WDCA1530	9.000	31.469	1.97	2.3
35	9.000	35.969	2.25	2.7
40	9.000	43.969	2.75	3.3
45	9.000	48.469	3.03	3.6
50	9.000	55.469	3.47	4.2
55	9.000	60.469	3.78	4.6
60	9.000	67.469	4.22	5.1
WDCA1830	12.500	31.469	2.73	3.1
35	12.500	35.969	3.12	3.5
40	12.500	43.969	3.82	4.3
45	12.500	48.469	4.21	4.8
50	12.500	55.469	4.82	5.5
55	12.500	60.469	5.25	6.0
60	12.500	67.469	5.86	6.7
WDCA2030	16.500	31.469	3.61	3.9
35	16.500	35.969	4.12	4.5
40	16.500	43.969	5.04	5.5
45	16.500	48.469	5.55	6.1
50	16.500	55.469	6.36	7.0
55	16.500	60.469	6.93	7.6
60	16.500	67.469	7.73	8.5
WDCA2430	20.500	31.469	4.48	4.7
35	20.500	35.969	5.12	5.5
40	20.500	43.969	6.26	6.7
45	20.500	48.469	6.90	7.4
50	20.500	55.469	7.90	8.5
55	20.500	60.469	8.61	9.3
60	20.500	67.469	9.60	10.4
WDCA2830	24.500	31.469	5.35	5.6
35	24.500	35.969	6.12	6.4
40	24.500	43.969	7.48	7.9
45	24.500	48.469	8.25	8.7
50	24.500	55.469	9.44	10.0
55	24.500	60.469	10.29	10.9
60	24.500	67.469	11.48	12.2

NOTE: Units listed in green satisfy IRC egress requirements. Check with your local code official to confirm egress requirements in your area.

Stationary Units

Call Size	Daylight Opening S.F.	Call Size	Daylight Opening S.F.
WDCA1030P	1.6	WDCA3030P	6.4
35	1.9	35	7.3
40	2.3	40	9.0
45	2.5	45	10.0
50	2.9	50	11.4
55	3.2	55	12.5
60	3.5	60	14.0
WDCA1530P	2.3	WDCA3530P	7.3
35	2.7	35	8.4
40	3.3	40	10.4
45	3.6	45	11.4
50	4.2	50	13.1
55	4.6	55	14.3
60	5.1	60	16.0
WDCA1830P	3.1	WDCA4030P	9.0
35	3.5	35	10.4
40	4.3	40	12.7
45	4.8	45	14.1
50	5.5	50	16.1
55	6.0	55	17.6
60	6.7	60	19.7
WDCA2030P	3.9	WDCA5030P	11.4
35	4.5	35	13.1
40	5.5	40	16.1
45	6.1	45	17.8
50	7.0	50	20.5
55	7.6	55	22.4
60	8.5	60	25.0
WDCA2430P	4.7	WDCA6030P	14.0
35	5.5	35	16.0
40	6.7	40	19.7
45	7.4	45	21.8
50	8.5	50	25.0
55	9.3	55	27.3
60	10.4	60	30.5
WDCA2830P	5.6		
35	6.4		
40	7.9		
45	8.7		
50	10.0		
55	10.9		
60	12.2		

200 Casement – 30° Bay Window w/ Operating Flankers

MW PRO SERIES 400, 300, 200



Note: Projections include 4-⁹/₁₆" wall.

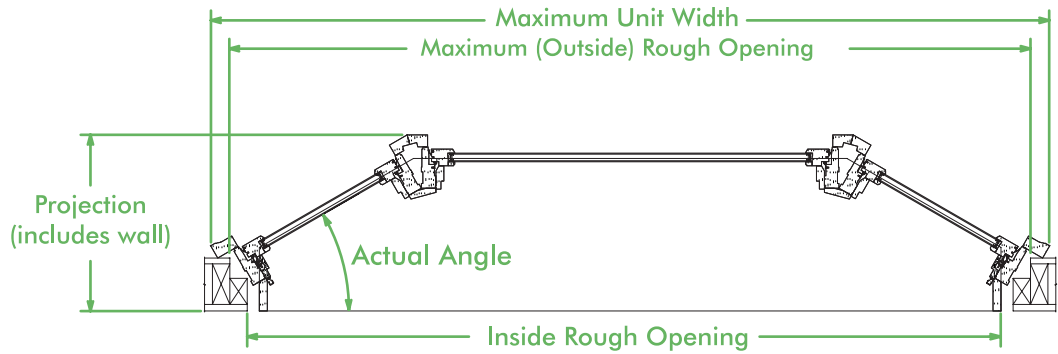

30° Angle Bay with 1-5 Flankers

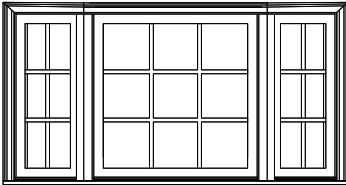

30° Angle Bay with 1-8 Flankers

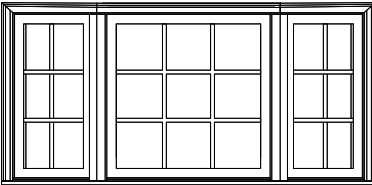

30° Angle Bay with 2-0 Flankers

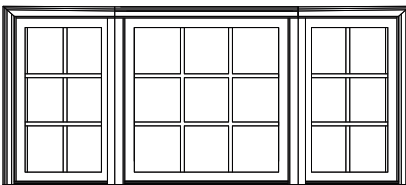

30° Angle Bay with 2-4 Flankers

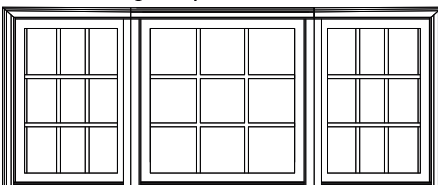

WIDTHS

Call Size	Max. Unit	Max. Ext. Rough Opening	Inside Rough Opening	Projection	Actual Angle
WDCA1530xx-30	72- ⁷ / ₁₆	68- ⁷ / ₁₆	64- ¹⁵ / ₁₆	15- ¹ / ₂	30°
WDCA1535xx-30	76- ¹⁵ / ₁₆	72- ¹⁵ / ₁₆	69- ⁷ / ₁₆	15- ¹ / ₂	30°
WDCA1540xx-30	84- ¹⁵ / ₁₆	80- ¹⁵ / ₁₆	77- ⁷ / ₁₆	15- ¹ / ₂	30°
WDCA1550xx-30	96- ⁷ / ₁₆	92- ⁷ / ₁₆	88- ¹⁵ / ₁₆	15- ¹ / ₂	30°
WDCA1560xx-30	108- ⁷ / ₁₆	104- ⁷ / ₁₆	100- ¹⁵ / ₁₆	15- ¹ / ₂	30°
WDCA1830xx-30	78- ¹ / ₂	74- ¹ / ₂	71	17- ¹ / ₄	30°
WDCA1835xx-30	83	79	75- ¹ / ₂	17- ¹ / ₄	30°
WDCA1840xx-30	91	87	83- ¹ / ₂	17- ¹ / ₄	30°
WDCA1850xx-30	102- ¹ / ₂	98- ¹ / ₂	95	17- ¹ / ₄	30°
WDCA1860xx-30	114- ¹ / ₂	110- ¹ / ₂	107	17- ¹ / ₄	30°
WDCA2030xx-30	85- ⁷ / ₁₆	81- ⁷ / ₁₆	77- ¹⁵ / ₁₆	19- ¹ / ₄	30°
WDCA2035xx-30	89- ¹⁵ / ₁₆	85- ¹⁵ / ₁₆	82- ⁷ / ₁₆	19- ¹ / ₄	30°
WDCA2040xx-30	97- ¹⁵ / ₁₆	93- ¹⁵ / ₁₆	90- ⁷ / ₁₆	19- ¹ / ₄	30°
WDCA2050xx-30	109- ⁷ / ₁₆	105- ⁷ / ₁₆	101- ¹⁵ / ₁₆	19- ¹ / ₄	30°
WDCA2060xx-30	121- ⁷ / ₁₆	117- ⁷ / ₁₆	113- ¹⁵ / ₁₆	19- ¹ / ₄	30°
WDCA2430xx-30	92- ³ / ₈	88- ³ / ₈	84- ⁷ / ₈	21- ¹ / ₄	30°
WDCA2435xx-30	96- ⁷ / ₈	92- ⁷ / ₈	89- ³ / ₈	21- ¹ / ₄	30°
WDCA2440xx-30	104- ⁷ / ₈	100- ⁷ / ₈	97- ³ / ₈	21- ¹ / ₄	30°
WDCA2450xx-30	116- ³ / ₈	112- ³ / ₈	108- ⁷ / ₈	21- ¹ / ₄	30°
WDCA2460xx-30	128- ³ / ₈	124- ³ / ₈	120- ⁷ / ₈	21- ¹ / ₄	30°

HEIGHTS

Call Size	Bay Unit	Rough Opening
3/0	37- ¹ / ₈	37- ⁵ / ₈
3/5	41- ⁵ / ₈	42- ¹ / ₈
4/0	49- ⁵ / ₈	50- ¹ / ₈
4/5	54- ¹ / ₈	54- ⁵ / ₈
5/0	61- ¹ / ₈	61- ⁵ / ₈
5/5	66- ¹ / ₈	66- ⁵ / ₈
6/0	73- ¹ / ₈	73- ⁵ / ₈

200 Casement – 30° Bay Window w/Three Operating Units



Note: Projections include 4-9/16" wall.

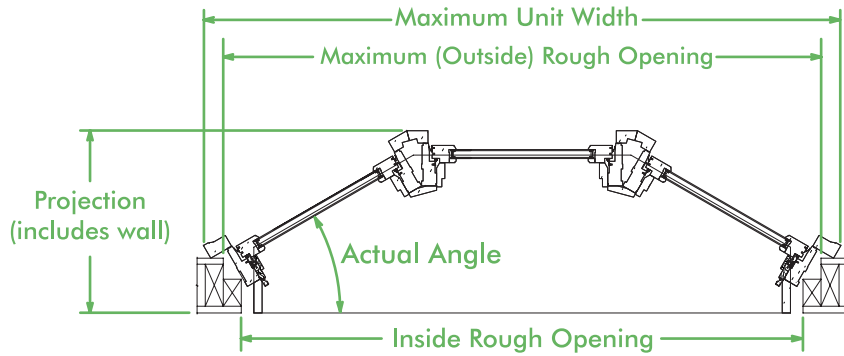

WIDTHS					
Call Size	Max. Unit	Max. Ext. Rough Opening	Inside Rough Opening	Projection	Actual Angle
WDCA15xx/3-30	53-3/16	49-3/16	45-11/16	15-1/2	30°
WDCA18xx/3-30	62-3/4	58-3/4	55-1/4	17-1/4	30°
WDCA20xx/3-30	73-11/16	69-11/16	66-3/16	19-1/4	30°
WDCA24xx/3-30	84-5/8	80-5/8	77-1/8	21-1/4	30°
WDCA28xx/3-30	95-9/16	91-9/16	88-1/16	23-1/4	30°
WDCA15xx/4-30	69-15/16	65-15/16	62-7/16	15-1/2	30°
WDCA18xx/4-30	83	79	75-1/2	17-1/4	30°
WDCA20xx/4-30	97-15/16	93-15/16	90-7/16	19-1/4	30°
WDCA24xx/4-30	112-7/8	108-7/8	105-3/8	21-1/4	30°
WDCA15xx/5-30	86-11/16	82-11/16	79-3/16	15-1/2	30°
WDCA18xx/5-30	103-1/4	99-1/4	95-3/4	17-1/4	30°
WDCA20xx/5-30	122-3/16	118-3/16	114-11/16	19-1/4	30°

30° Angle Bay
1-5 Flankers with 1-5 Center

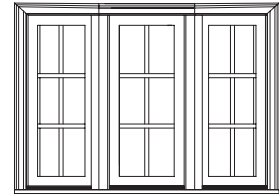

30° Angle Bay
1-8 Flankers with 1-8 Center

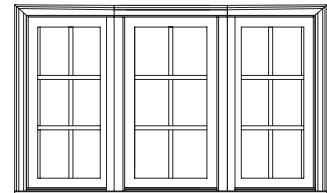

30° Angle Bay
2-0 Flankers with 2-0 Center

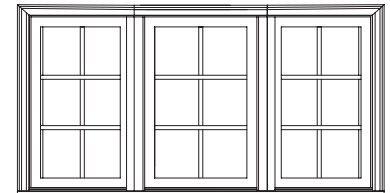

30° Angle Bay
2-4 Flankers with 2-4 Center

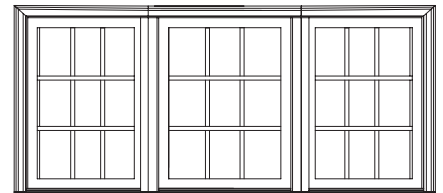

30° Angle Bay
2-8 Flankers with 2-8 Center

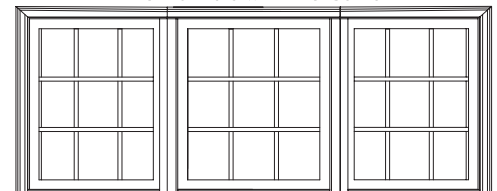

HEIGHTS		
Call Size	Bay Unit	Rough Opening
3/0	37-1/8	37-5/8
3/5	41-5/8	42-1/8
4/0	49-5/8	50-1/8
4/5	54-1/8	54-5/8
5/0	61-1/8	61-5/8
5/5	66-1/8	66-5/8
6/0	73-1/8	73-5/8

200 Casement – 45° Bay Window w/ Operating Flankers

MW PRO SERIES 400, 300, 200

Note: Projections include 4-⁹/₁₆" wall.

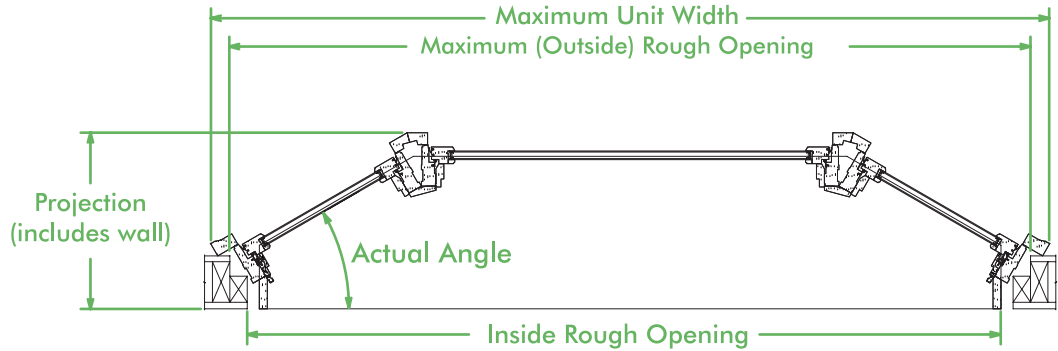

45° Angle Bay with 1-5 Flankers

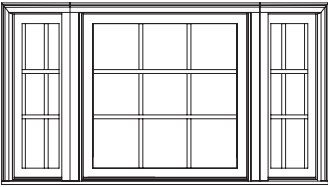

45° Angle Bay with 1-8 Flankers

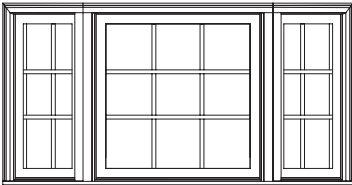

45° Angle Bay with 2-0 Flankers

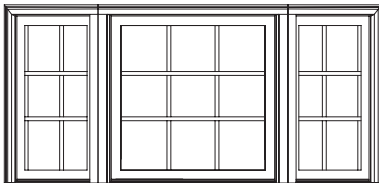

45° Angle Bay with 2-4 Flankers

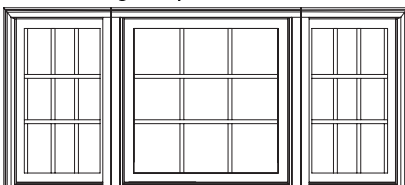

WIDTHS

Call Size	Max. Unit	Max. Ext. Rough Opening	Inside Rough Opening	Projection	Actual Angle
WDCA1530xx-45	68 ⁻¹¹ / ₁₆	63 ⁻³ / ₈	59 ⁻⁷ / ₈	19 ⁻¹³ / ₁₆	45°
WDCA1535xx-45	73 ⁻³ / ₁₆	67 ⁻⁷ / ₈	64 ⁻³ / ₈	19 ⁻¹³ / ₁₆	45°
WDCA1540xx-45	81 ⁻³ / ₁₆	75 ⁻⁷ / ₈	72 ⁻³ / ₈	19 ⁻¹³ / ₁₆	45°
WDCA1550xx-45	92 ⁻¹¹ / ₁₆	87 ⁻³ / ₈	83 ⁻⁷ / ₈	19 ⁻¹³ / ₁₆	45°
WDCA1560xx-45	104 ⁻¹¹ / ₁₆	99 ⁻³ / ₈	95 ⁻⁷ / ₈	19 ⁻¹³ / ₁₆	45°
WDCA1830xx-45	73 ⁻¹¹ / ₁₆	68 ⁻³ / ₈	64 ⁻⁷ / ₈	22 ⁻⁵ / ₁₆	45°
WDCA1835xx-45	78 ⁻³ / ₁₆	72 ⁻⁷ / ₈	69 ⁻³ / ₈	22 ⁻⁵ / ₁₆	45°
WDCA1840xx-45	86 ⁻³ / ₁₆	80 ⁻⁷ / ₈	77 ⁻³ / ₈	22 ⁻⁵ / ₁₆	45°
WDCA1850xx-45	97 ⁻¹¹ / ₁₆	92 ⁻³ / ₈	88 ⁻⁷ / ₈	22 ⁻⁵ / ₁₆	45°
WDCA1860xx-45	109 ⁻¹¹ / ₁₆	104 ⁻³ / ₈	100 ⁻⁷ / ₈	22 ⁻⁵ / ₁₆	45°
WDCA2030xx-45	79 ⁻⁵ / ₁₆	74	70 ⁻¹ / ₂	25 ⁻¹ / ₈	45°
WDCA2035xx-45	83 ⁻¹³ / ₁₆	78 ⁻¹ / ₂	75	25 ⁻¹ / ₈	45°
WDCA2040xx-45	91 ⁻¹³ / ₁₆	86 ⁻¹ / ₂	83	25 ⁻¹ / ₈	45°
WDCA2050xx-45	103 ⁻⁵ / ₁₆	98	94 ⁻¹ / ₂	25 ⁻¹ / ₈	45°
WDCA2060xx-45	115 ⁻⁵ / ₁₆	110	106 ⁻¹ / ₂	25 ⁻¹ / ₈	45°
WDCA2430xx-45	85	79 ⁻¹¹ / ₁₆	76 ⁻³ / ₁₆	27 ⁻¹⁵ / ₁₆	45°
WDCA2435xx-45	89 ⁻¹ / ₂	84 ⁻³ / ₁₆	80 ⁻¹¹ / ₁₆	27 ⁻¹⁵ / ₁₆	45°
WDCA2440xx-45	97 ⁻¹ / ₂	92 ⁻³ / ₁₆	88 ⁻¹¹ / ₁₆	27 ⁻¹⁵ / ₁₆	45°
WDCA2450xx-45	109	103 ⁻¹¹ / ₁₆	100 ⁻³ / ₁₆	27 ⁻¹⁵ / ₁₆	45°
WDCA2460xx-45	121	115 ⁻¹¹ / ₁₆	112 ⁻³ / ₁₆	27 ⁻¹⁵ / ₁₆	45°

HEIGHTS

Call Size	Bay Unit	Rough Opening
3/0	37 ⁻¹ / ₈	37 ⁻⁵ / ₈
3/5	41 ⁻⁵ / ₈	42 ⁻¹ / ₈
4/0	49 ⁻⁵ / ₈	50 ⁻¹ / ₈
4/5	54 ⁻¹ / ₈	54 ⁻⁵ / ₈
5/0	61 ⁻¹ / ₈	61 ⁻⁵ / ₈
5/5	66 ⁻¹ / ₈	66 ⁻⁵ / ₈
6/0	73 ⁻¹ / ₈	73 ⁻⁵ / ₈

200 Casement – 45° Bay Window w/Three Operating Units

Note: Projections include 4-⁹/₁₆" wall.

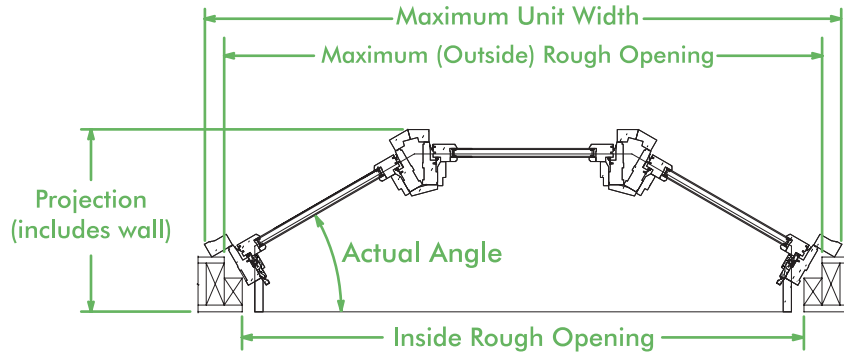

WIDTHS					
Call Size	Max. Unit	Max. Ext. Rough Opening	Inside Rough Opening	Projection	Actual Angle
WDCA15xx/3-45	49- ⁷ / ₁₆	44- ¹ / ₈	40- ⁵ / ₈	19- ¹³ / ₁₆	45°
WDCA18xx/3-45	57- ¹⁵ / ₁₆	52- ⁵ / ₈	49- ¹ / ₈	22- ⁵ / ₁₆	45°
WDCA20xx/3-45	67- ⁹ / ₁₆	62- ¹ / ₄	58- ³ / ₄	25- ¹ / ₈	45°
WDCA24xx/3-45	77- ¹ / ₄	71- ¹⁵ / ₁₆	68- ⁷ / ₁₆	27- ¹⁵ / ₁₆	45°
WDCA28xx/3-45	86- ⁷ / ₈	81- ⁹ / ₁₆	78- ¹ / ₁₆	30- ¹³ / ₁₆	45°
WDCA15xx/4-45	66- ³ / ₁₆	60- ⁷ / ₈	57- ³ / ₈	19- ¹³ / ₁₆	45°
WDCA18xx/4-45	78- ³ / ₁₆	72- ⁷ / ₈	69- ³ / ₈	22- ⁵ / ₁₆	45°
WDCA20xx/4-45	91- ¹³ / ₁₆	86- ¹ / ₂	83	25- ¹ / ₈	45°
WDCA24xx/4-45	105- ¹ / ₂	100- ³ / ₁₆	96- ¹¹ / ₁₆	27- ¹⁵ / ₁₆	45°
WDCA28xx/4-45	119- ¹ / ₈	113- ¹³ / ₁₆	110- ⁵ / ₁₆	30- ¹³ / ₁₆	45°
WDCA15xx/5-45	82- ¹⁵ / ₁₆	77- ⁵ / ₈	74- ¹ / ₈	19- ¹³ / ₁₆	45°
WDCA18xx/5-45	98- ⁷ / ₁₆	93- ¹ / ₈	89- ⁵ / ₈	22- ⁵ / ₁₆	45°
WDCA20xx/5-45	116- ¹ / ₁₆	110- ¹ / ₄	107- ¹ / ₄	25- ¹ / ₈	45°

HEIGHTS		
Call Size	Bay Unit	Rough Opening
3/0	37- ¹ / ₈	37- ⁵ / ₈
3/5	41- ⁵ / ₈	42- ¹ / ₈
4/0	49- ⁵ / ₈	50- ¹ / ₈
4/5	54- ¹ / ₈	54- ⁵ / ₈
5/0	61- ¹ / ₈	61- ⁵ / ₈
5/5	66- ¹ / ₈	66- ⁵ / ₈
6/0	73- ¹ / ₈	73- ⁵ / ₈

45° Angle Bay
1-5 Flankers with 1-5 Center

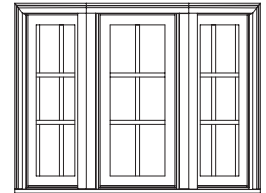

45° Angle Bay
1-8 Flankers with 1-8 Center

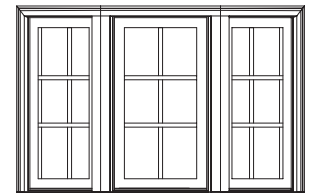

45° Angle Bay
2-0 Flankers with 2-0 Center

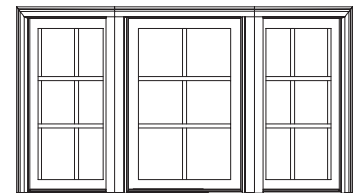

45° Angle Bay
2-4 Flankers with 2-4 Center



45° Angle Bay
2-8 Flankers with 2-8 Center

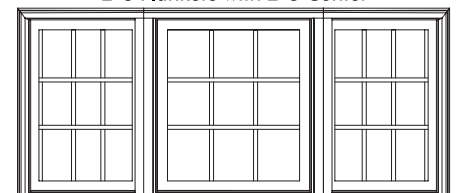

200 Casement – 4 Wide Bow Window Details

MW PRO SERIES 400, 300, 200

HEIGHTS		
Call Size	Bay Unit	Rough Opening
3/0	37 ^{-1/8}	37 ^{-5/8}
3/5	41 ^{-5/8}	42 ^{-1/8}
4/0	49 ^{-5/8}	50 ^{-1/8}
4/5	54 ^{-1/8}	54 ^{-5/8}
5/0	61 ^{-1/8}	61 ^{-5/8}
5/5	66 ^{-1/8}	66 ^{-5/8}
6/0	73 ^{-1/8}	73 ^{-5/8}



Note: Projections include 4^{-9/16}" wall.

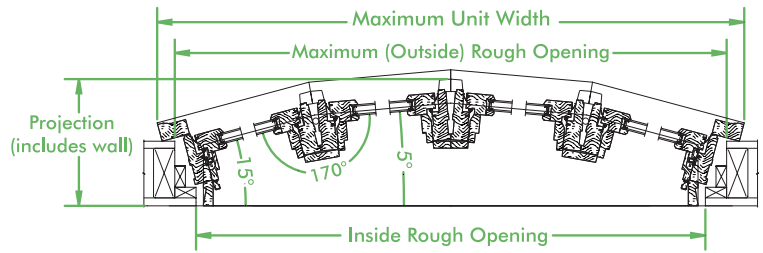

1-5 Bow - 4 Wide



1-8 Bow - 4 Wide



WIDTHS				
Call Size	Max. Unit	Max. Rough Opening	Projection	Unit Dimension
WDCA15xx/4BOW	71 ^{-1/16}	67 ^{-1/16}	12 ^{-1/4}	65 ^{-9/16}

WIDTHS				
Call Size	Max. Unit	Max. Rough Opening	Projection	Unit Dimension
WDCA18xx/4BOW	84 ^{-13/16}	80 ^{-13/16}	13 ^{-7/16}	79 ^{-5/16}

2-0 Bow - 4 Wide



2-4 Bow - 4 Wide



WIDTHS				
Call Size	Max. Unit	Max. Rough Opening	Projection	Unit Dimension
WDCA20xx/4BOW	100 ^{-1/2}	96 ^{-1/2}	14 ^{-7/8}	95

WIDTHS				
Call Size	Max. Unit	Max. Rough Opening	Projection	Unit Dimension
WDCA24xx/4BOW	116 ^{-3/16}	112 ^{-3/16}	16 ^{-1/4}	110 ^{-11/16}

Note: Windows 1 and 4 are operating, windows 2 and 3 are stationary. All four windows operating is optional, upcharge applies.

Note: Projections include 4-⁹/₁₆" wall.

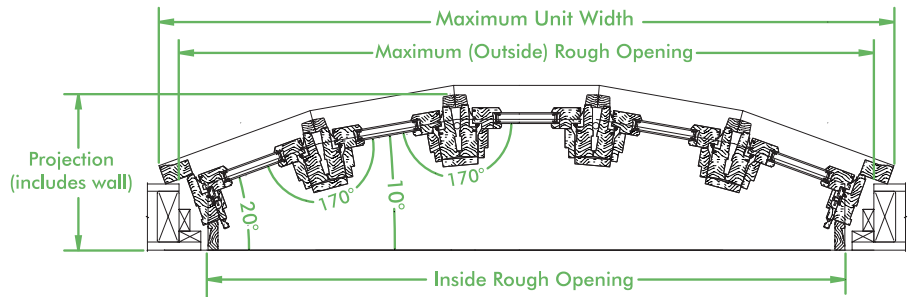

HEIGHTS		
Call Size	Bay Unit	Rough Opening
3/0	37- ¹ / ₈	37- ⁵ / ₈
3/5	41- ⁵ / ₈	42- ¹ / ₈
4/0	49- ⁵ / ₈	50- ¹ / ₈
4/5	54- ¹ / ₈	54- ⁵ / ₈
5/0	61- ¹ / ₈	61- ⁵ / ₈
5/5	66- ¹ / ₈	66- ⁵ / ₈
6/0	73- ¹ / ₈	73- ⁵ / ₈

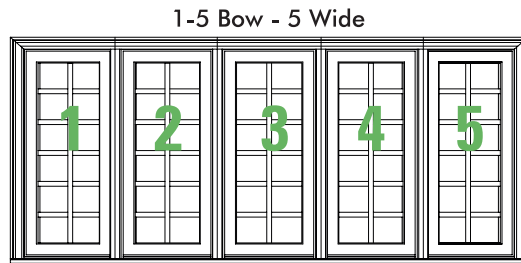

WIDTHS				
Call Size	Max. Unit	Max. Rough Opening	Projection	Unit Dimension
WDCA15xx/5BOW	87- ⁵ / ₁₆	84- ⁹ / ₁₆	15- ¹ / ₄	81- ⁹ / ₁₆

Note: Windows 1 & 5 are operating, windows 2, 3 & 4 are stationary. All five windows operating is optional, upcharge applies.



WIDTHS				
Call Size	Max. Unit	Max. Rough Opening	Projection	Unit Dimension
WDCA18xx/5BOW	104- ⁵ / ₁₆	101- ⁹ / ₁₆	17- ¹ / ₁₆	98- ⁹ / ₁₆



WIDTHS				
Call Size	Max. Unit	Max. Rough Opening	Projection	Unit Dimension
WDCA20xx/5BOW	123- ¹¹ / ₁₆	120- ¹⁵ / ₁₆	19- ¹ / ₈	117- ¹⁵ / ₁₆

		Widths					
		2' - 0 1/4"	2' - 4 1/4"	2' - 8 1/4"	3' - 0"	3' - 4 1/2"	4' - 0 1/2"
		2' - 1 1/4"	2' - 5 1/4"	2' - 9 1/4"	3' - 1"	3' - 5 1/2"	4' - 1 1/2"
		2-0	2-4	2-8	3-0	3-5	4-0
Heights	Unit Dimension						
	Rough Opening						
	Call Size						
1' - 8 1/4"	1-8						
2' - 0 1/4"	2-0						
2' - 4 1/4"	2-4						

		One Wide by Two High Units					
		2' - 0 1/4"	2' - 4 1/4"	2' - 8 1/4"	3' - 0"	3' - 4 1/2"	4' - 0 1/2"
		2' - 1 1/4"	2' - 5 1/4"	2' - 9 1/4"	3' - 1"	3' - 5 1/2"	4' - 1 1/2"
		2-0	2-4	2-8	3-0	3-5	4-0
Heights	Unit Dimension						
	Rough Opening						
	Call Size						
3' - 4 1/2"	1-8						
4' - 0 1/2"	2-0						
4' - 8 1/2"	2-4						

Widths

Heights	Widths			
	6' - 0 3/4"	7' - 0 3/4"	8' - 0 3/4"	9' - 0"
	6' - 1 3/4"	7' - 1 3/4"	8' - 1 3/4"	9' - 1"
	2-0 Triple	2-4 Triple	2-8 Triple	3-0 Triple
1' - 8 1/4"				
2' - 0 1/4"				
2' - 4 1/4"				

Widths





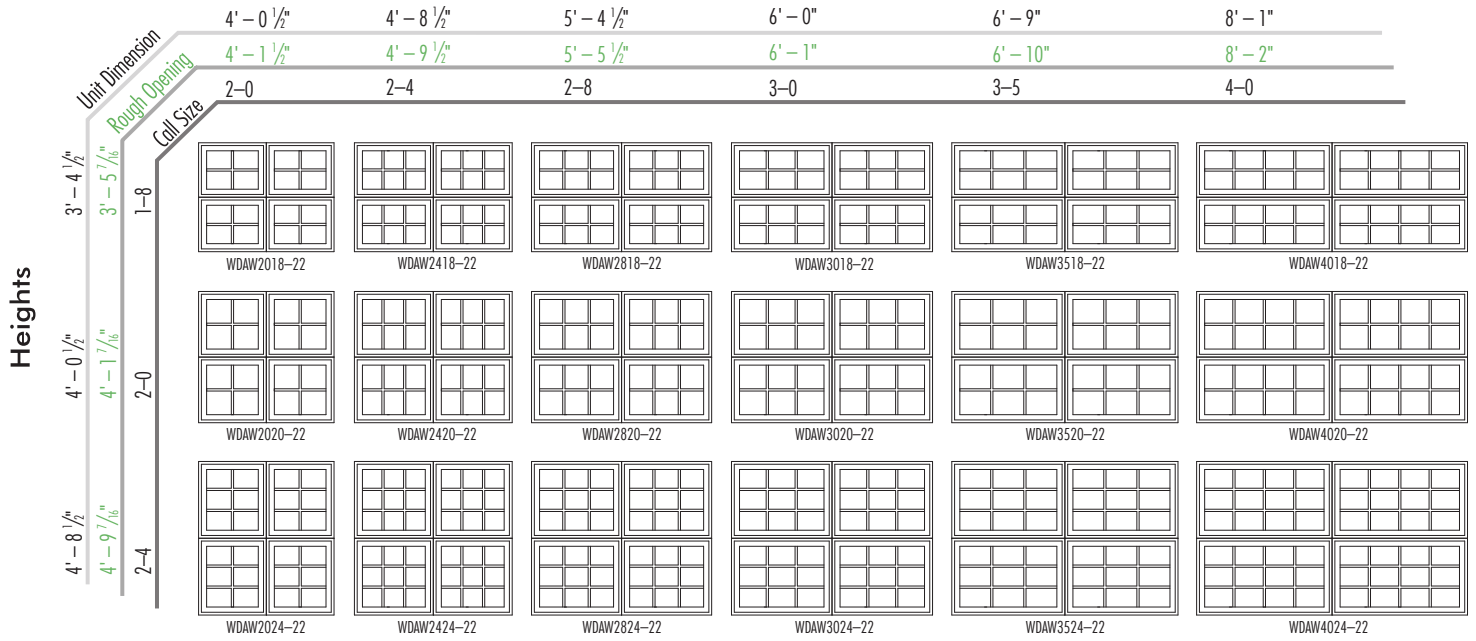



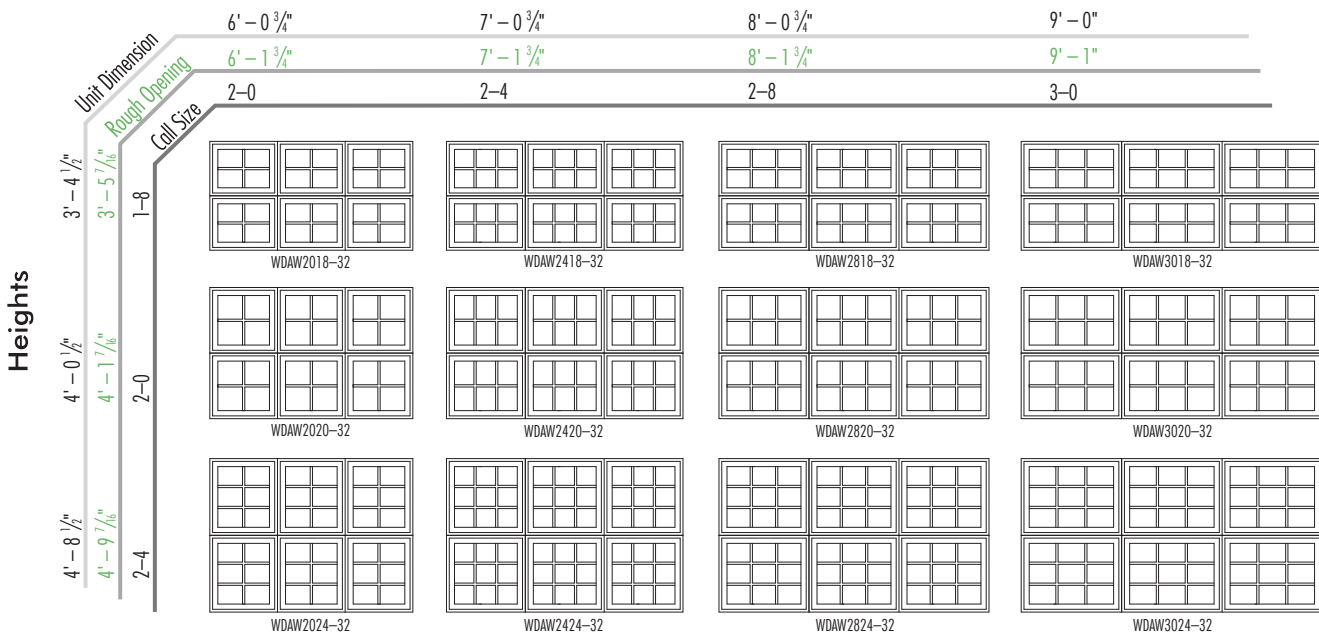

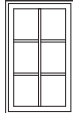

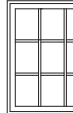
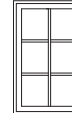
Heights	Widths					
	4' - 0 1/2"	4' - 8 1/2"	5' - 4 1/2"	6' - 0"	6' - 9"	8' - 1"
	4' - 1 1/2"	4' - 9 1/2"	5' - 5 1/2"	6' - 1"	6' - 10"	8' - 2"
	2-0 Twin	2-4 Twin	2-8 Twin	3-0 Twin	3-5 Twin	4-0 Twin
1' - 8 1/4"						
2' - 0 1/4"						
2' - 4 1/4"						

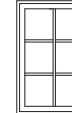
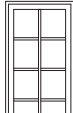
Two Wide by Two High Units Widths

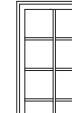
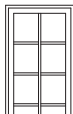

Three Wide by Two High Units Widths

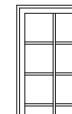

		Widths					
		2' - 0 1/4"	2' - 4 1/4"	2' - 8 1/4"	3' - 0"	3' - 4 1/2"	4' - 0 1/2"
		2' - 1 1/4"	2' - 5 1/4"	2' - 9 1/4"	3' - 1"	3' - 5 1/2"	4' - 1 1/2"
		2-0 Picture	2-4 Picture	2-8 Picture	3-0 Picture	3-5 Picture	4-0 Picture
Heights	Unit Dimension						
	Rough Opening						
	Coll. Size						
3' - 4 1/2"	3-5						
4' - 0 1/2"	4-0						
5' - 0"	5-0						
		WD AW 2035P	WD AW 2435P	WD AW 2835P	WD AW 3035P	WD AW 3535P	WD AW 4035P
		WD AW 2040P	WD AW 2440P	WD AW 2840P	WD AW 3040P	WD AW 3540P	WD AW 4040P
		WD AW 2050P	WD AW 2450P	WD AW 2850P	WD AW 3050P	WD AW 3550P	WD AW 4050P

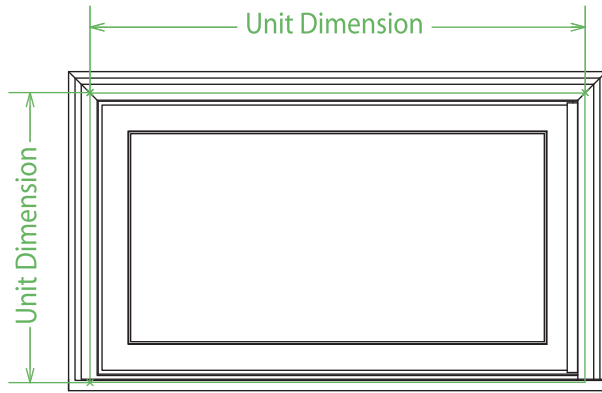

Operating Units, WIDTH

CALL SIZE (WIDTH)	2-0	2-4	2-8	3-0	3-5	4-0
ONE WIDE	24 ¹ / ₄	28 ¹ / ₄	32 ¹ / ₄	36	40 ¹ / ₂	48 ¹ / ₂
TWO WIDE	48 ¹ / ₂	56 ¹ / ₂	64 ¹ / ₂	72	81	97
THREE WIDE	72 ³ / ₄	84 ³ / ₄	96 ³ / ₄	108	N/A	N/A
FOUR WIDE	97	113	N/A	N/A	N/A	N/A

Operating & Stationary Units, HEIGHT*

CALL SIZE HEIGHT	ONE HEIGHT	TWO HEIGHT	THREE HEIGHT
1-8	20 ¹ / ₄	40 ¹ / ₂	60 ³ / ₄
2-0	24 ¹ / ₄	48 ¹ / ₂	72 ³ / ₄
2-4	28 ¹ / ₄	56 ¹ / ₂	84 ³ / ₄

* MW sill nosing ledge will add 1/16" to this dimension.

Stationary Units, WIDTH

CALL SIZE (WIDTH)	2-0	2-4	2-8	3-0	3-5	4-0
ONE WIDE	24 ¹ / ₄	28 ¹ / ₄	32 ¹ / ₄	36	40 ¹ / ₂	48 ¹ / ₂
TWO WIDE	48 ¹ / ₂	56 ¹ / ₂	64 ¹ / ₂	72	81	97
THREE WIDE	72 ³ / ₄	84 ³ / ₄	96 ³ / ₄	108	N/A	N/A

Stationary Units, HEIGHT

CALL SIZE (HEIGHT)	HEIGHT IN INCHES
1-8	20 ¹ / ₄
2-0	24 ¹ / ₄
2-4	28 ¹ / ₄
3-5	40 ¹ / ₂
4-0	48 ¹ / ₂
5-0	60

Picture Over Single Awning Units, HEIGHT

CALL SIZE (HEIGHT)	HEIGHT IN INCHES	CALL SIZE (HEIGHT)	HEIGHT IN INCHES	CALL SIZE (HEIGHT)	HEIGHT IN INCHES
1-8/3-5	60 ³ / ₄	2-0/3-5	64 ³ / ₄	2-4/3-6	68 ³ / ₄
1-8/4-0	68 ³ / ₄	2-0/4-0	72 ³ / ₄	2-4/4-0	76 ³ / ₄
1-8/5-0	80 ¹ / ₄	2-0/5-0	84 ¹ / ₄	2-4/5-0	88 ¹ / ₄

Operating Units

Call Size	Clear Opening Width	Clear Opening Height	Clear Opening S.F.	Daylight Opening S.F.
WDAW2018	16.500	11.500	1.32	1.9
20	16.500	15.500	1.78	2.4
24	16.500	19.500	2.23	2.9
WDAW2418	20.500	11.500	1.64	2.3
20	20.500	15.500	2.21	2.9
24	20.500	19.500	2.78	3.5
WDAW2818	24.500	11.500	1.96	2.7
20	24.500	15.500	2.64	3.4
24	24.500	19.500	3.32	4.2

Call Size	Clear Opening Width	Clear Opening Height	Clear Opening S.F.	Daylight Opening S.F.
WDAW3018	31.563	11.500	2.52	3.1
20	31.563	15.500	3.40	3.9
24	31.563	19.500	4.27	4.7
WDAW3518	36.063	11.500	2.88	3.5
20	36.063	15.500	3.88	4.5
24	36.063	19.500	4.88	5.5
WDAW4018	44.063	11.500	3.52	4.3
20	44.063	15.500	4.74	5.5
24	44.063	19.500	5.97	6.7

NOTE: Awning units do NOT satisfy egress requirements.

Stationary Units

Call Size	Daylight Opening S.F.
WDAW2018P	1.9
20	2.4
24	2.9
35	4.5
40	5.5
50	7.0
WDAW2418P	2.3
20	2.9
24	3.5
35	5.5
40	6.7
50	8.5
WDAW2818P	2.7
20	3.4
24	4.2
35	6.4
40	7.9
50	10.0

Call Size	Daylight Opening S.F.
WDAW3018P	3.1
20	3.9
24	4.7
35	7.3
40	9.0
50	11.4
WDAW3518P	3.5
20	4.5
24	5.5
35	8.4
40	10.4
50	13.1
WDAW4018P	4.3
20	5.5
24	6.7
35	10.4
40	12.7
50	16.1

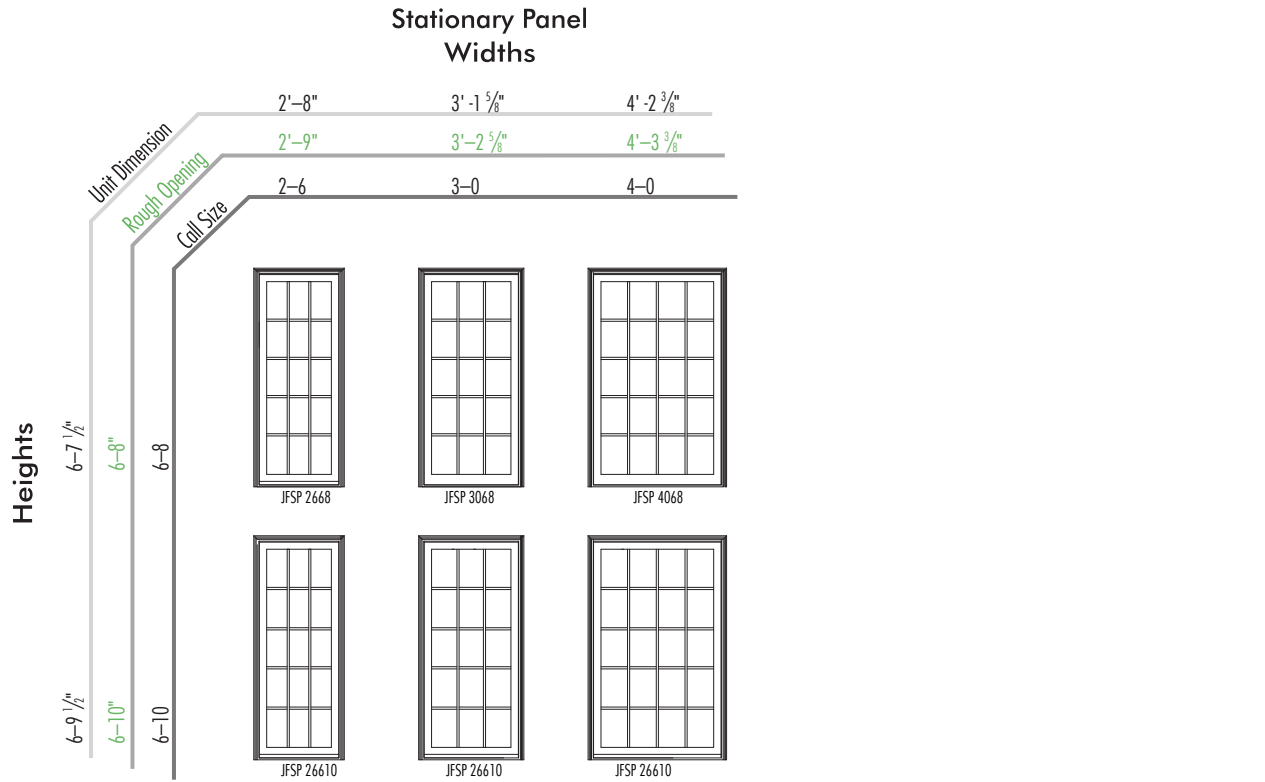
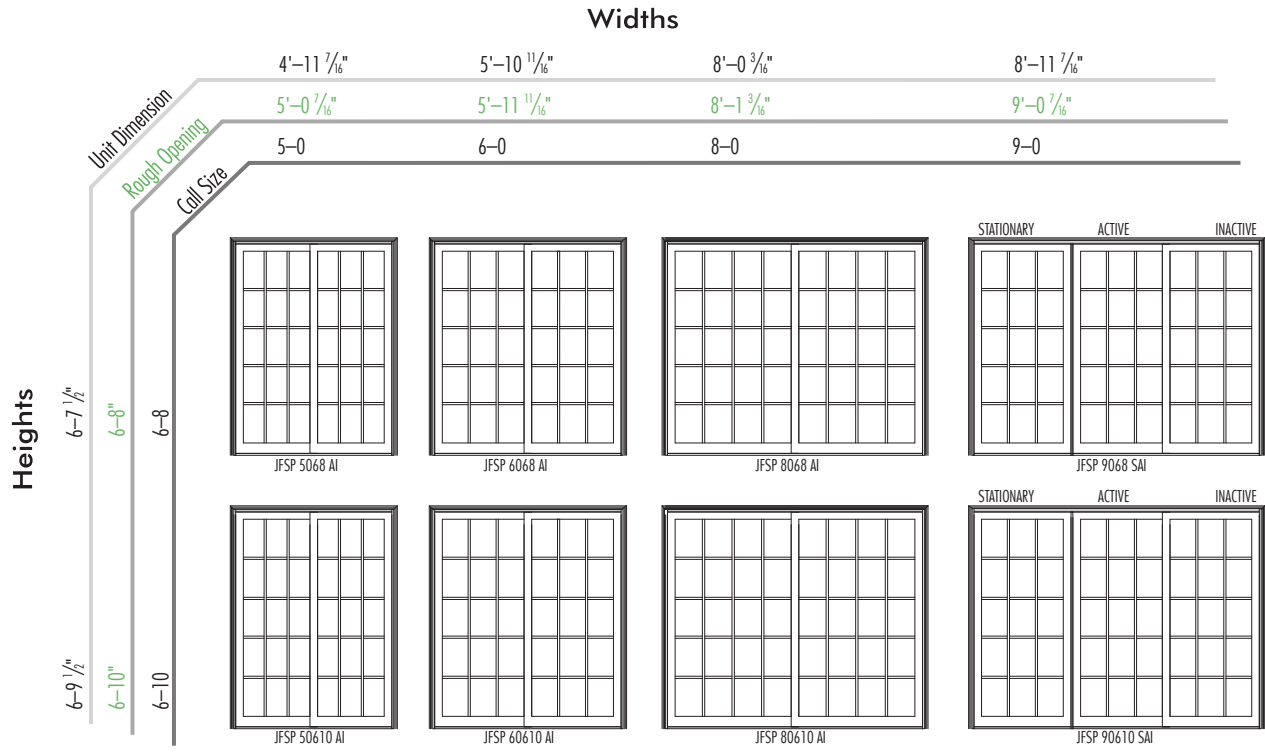



Standard & French Sliding Patio Doors – Transom & Elliptical Units

MW PRO SERIES 400, 300, 200











Widths





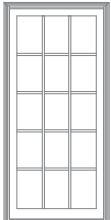

		4'-11 7/16"	5'-10 11/16"	8'-0 3/16"	8'-11 7/16"
		5'-0"	6'-0"	8'-0"	9'-0"
Heights	Unit Dimension	0-11 3/8"	0-11 3/8"	0-11 3/8"	0-11 3/8"
	Rough Opening	0-11 7/8"	0-11 7/8"	0-11 3/8"	0-11 7/8"
	Call Size	0-10"	0-10"	0-10"	0-10"
		JFSP50010TN	JFSP60010TN	JFSP80010SGTN	JFSP90010SGTN
		JFSP50010SGTN	JFSP60010SGTN	JFSP80010SGTN	JFSP90010SGTN
		JFSP5010TN	JFSP6010TN	JFSP8010SGTN	JFSP9010SGTN
		JFSP5010SGTN	JFSP6010SGTN	JFSP8010SGTN	JFSP9010SGTN
		JFSP5012TN	JFSP6012TN	JFSP8012TN	JFSP9012SGTN
		JFSP5012SGTN	JFSP6012SGTN	JFSP8012SGTN	JFSP9012SGTN
		JFSP5020TN	JFSP6020TN	JFSP8020TN	JFSP9020TN
		JFSP5020SGTN	JFSP6020SGTN	JFSP8020SGTN	JFSP9020SGTN
		JFSP5024TN	JFSP6024TN	JFSP9024TN	JFSP9024TN
	JFSP5024SGTN	JFSP6024SGTN	JFSP9024SGTN	JFSP9024SGTN	

Widths







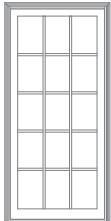
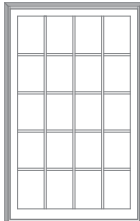
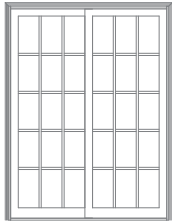
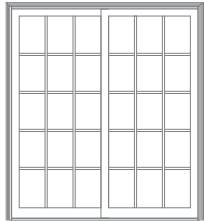

















		4'-2 3/8"	4'-11 7/16"	5'-10 11/16"	8'-0 3/16"	8'-11 7/16"
		4'-3 3/8"	5'-0 7/16"	5'-11 11/16"	8'-1 3/16"	9'-0 7/16"
		4-0	5-0	6-0	8-0	9-0
Heights	Unit Dimension	0'-10 1/2"	1'-0 11/16"	1'-4 1/8"	1'-8 9/16"	2'-0 5/8"
	Rough Opening	0'-11"	1'-1 3/16"	1'-4 3/8"	1'-9 1/16"	2'-1 1/8"
	Call Size					
		SPDR40EL	SPDR50EL	SPDR60EL	SPDR80EL	SPDR90EL

Standard & French Sliding Patio Doors – Transom & Circle Head Units

Heights	Widths		
	2'-8"	3'-1 5/8"	4'-2 3/8"
Unit Dimension	2'-9"	3'-2 5/8"	4'-3 3/8"
Rough Opening	2-6	3-0	4-0
Call Size			
0-11 3/8"			
1-1 1/8"			
1-3 3/8"			
2-2 5/8"			
2-6 5/8"			
0-10			

Heights	Widths				
	2'-8"	3'-1 5/8"	4'-2 3/8"	4'-11 7/16"	5'-10 11/16"
Unit Dimension	2'-9"	3'-2 5/8"	4'-3 3/8"	5'-0 7/16"	5'-11 11/16"
Rough Opening	2-6	3-0	4-0	5-0	6-0
Call Size					
1'-5 1/4"					
1'-5 3/4"	1'-5 1/4"	1'-8 1/16"	2'-2 2/16"	2'-7"	3'-0 5/8"
	1'-5 3/4"	1'-8 9/16"	2'-2 15/16"	2'-7 1/2"	3'-1 1/8"
					

Standard Colonial Grille Pattern Widths

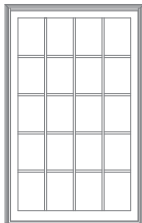
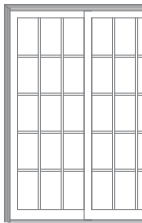
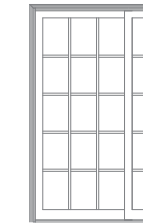
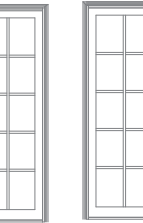
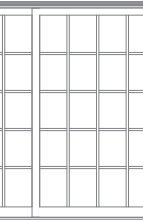













	4' - 2 3/8"	4' - 11 7/16"	5' - 10 11/16"	8' - 0 3/16"	8' - 11 7/16"
Unit Dimension	4' - 2 3/8"	4' - 11 7/16"	5' - 10 11/16"	8' - 0 3/16"	8' - 11 7/16"
Rough Opening	4' - 3 3/8"	5' - 0 7/16"	5' - 11 11/16"	8' - 1 3/16"	9' - 0 7/16"
Call Size	4-0	5-0	6-0	8-0	9-0
0-6	 JFSP4006AH 1' - 3 13/16" 1' - 4 5/16"	 JFSP5006AH 1' - 5 5/16" 1' - 5 13/16"	 JFSP6006AH 1' - 7 3/16" 1' - 7 11/16"	 JFSP8006AH 1' - 11 7/16" 1' - 11 15/16"	 JFSP9006AH 2' - 1 5/16" 2' - 1 13/16"
0-10	 JFSP40010AH 1' - 7 13/16" 1' - 8 5/16"	 JFSP50010AH 1' - 9 5/16" 1' - 9 13/16"	 JFSP60010AH 1' - 11 3/16" 1' - 11 11/16"	 JFSP80010AH 2' - 3 7/16" 2' - 3 15/16"	 JFSP90010AH 2' - 5 5/16" 2' - 5 13/16"
1-0	 JFSP4010AH 1' - 9 13/16" 1' - 10 5/16"	 JFSP5010AH 1' - 11 5/16" 1' - 11 13/16"	 JFSP6010AH 2' - 1 3/16" 2' - 1 11/16"	 JFSP8010AH 2' - 5 7/16" 2' - 5 15/16"	 JFSP9010AH 2' - 7 5/16" 2' - 7 13/16"
1-2	 JFSP4012AH 1' - 11 13/16" 2' - 0 5/16"	 JFSP5012AH 2' - 1 5/16" 2' - 1 13/16"	 JFSP6012AH 2' - 3 3/16" 2' - 3 11/16"	 JFSP8012AH 2' - 7 7/16" 2' - 7 15/16"	 JFSP9012AH 2' - 9 5/16" 2' - 9 13/16"
2-0	 JFSP4020AH 2' - 11 1/16" 2' - 11 3/16"	 JFSP5020AH 3' - 0 3/16" 3' - 1 1/16"	 JFSP6020AH 3' - 2 7/16" 3' - 2 13/16"	 JFSP8020AH 3' - 6 11/16" 3' - 7 3/16"	
					

Heights

Unit height dimension is listed first under individual windows

Rough opening height dimension is listed second under individual windows

Optional Gothic Grille Pattern Widths

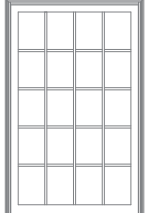
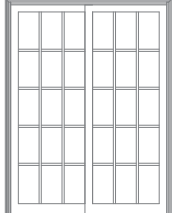
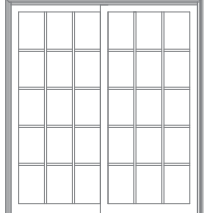
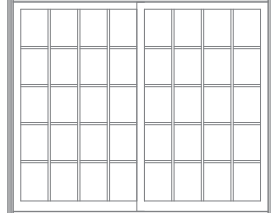
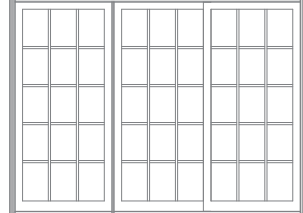
Heights	Optional Gothic Grille Pattern Widths				
	4' - 2 3/8"	4' - 11 7/16"	5' - 10 11/16"	8' - 0 3/16"	8' - 11 7/16"
	4'-0"	5'-0"	6'-0"	8'-0"	9'-0"
1-0	 JFSP4010AH 1' - 9 13/16" 1' - 10 3/16"	 JFSP5010AH 1' - 11 5/16" 1' - 11 13/16"	 JFSP6010AH 2' - 1 3/16" 2' - 1 11/16"	 JFSP8010AH 2' - 5 7/16" 2' - 5 15/16"	 JFSP9010AH 2' - 7 5/16" 2' - 7 13/16"
1-2	 JFSP4012AH 1' - 11 13/16" 2' - 0 5/16"	 JFSP5012AH 2' - 1 9/16" 2' - 1 13/16"	 JFSP6012AH 2' - 3 3/16" 2' - 3 11/16"	 JFSP8012AH 2' - 7 7/16" 2' - 7 15/16"	 JFSP9012AH 2' - 9 5/16" 2' - 9 13/16"
2-0	 JFSP4020AH 2' - 11 1/16" 2' - 11 9/16"	 JFSP5020AH 3' - 0 9/16" 3' - 1 1/16"	 JFSP6020AH 3' - 2 7/16" 3' - 2 15/16"	 JFSP8020AH 3' - 6 11/16" 3' - 7 3/16"	
					

Unit height dimension is listed first under individual windows
 Rough Opening height dimension is listed second under individual windows

Unit Dimension
 Rough Opening
 Call Size

Center Hinged Patio Doors – Operating Units

MW PRO SERIES 400, 300, 200

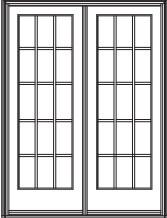
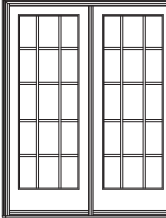
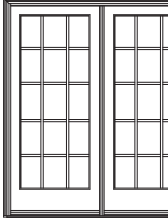
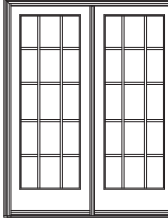
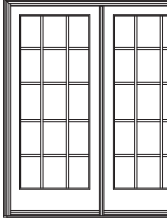
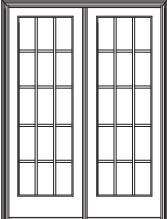
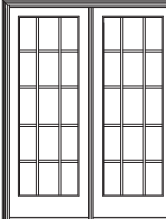
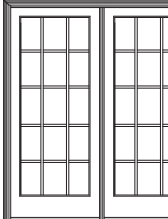
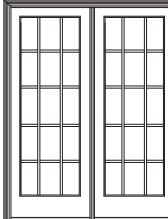
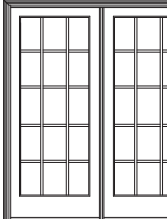
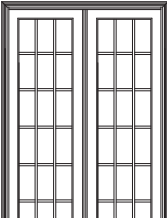
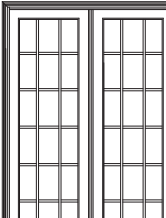
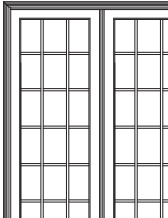
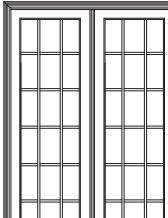
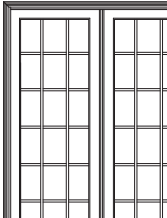
		Widths				
		4'-11 7/16"	5'-3 7/16"	5'-10 11/16"	7'-10 5/8"	8'-9 7/16"
		5'-0 7/16"	5'-4 7/16"	5'-11 11/16"	7'-11 5/8"	8'-10 7/16"
		5-0	5-4	6-0	8-0	9-0
Heights	Unit Dimension					
	Rough Opening					
	Call Size					
	6-7 1/2"					
		JFHP 5068	JFHP 5468	JFHP 6068	JFHP 8068	JFHP 9068
	6-8"					
	6-8					
	6-9 1/2"					
		JFHP 50610	JFHP 54610	JFHP 60610	JFHP 80610	JFHP 90610
6-10"						
6-10						
7-11 1/2"						
	JFHP 50610	JFHP 54610	JFHP 60610	JFHP 80610	JFHP 90610	
8-0"						
8-0						

Center Hinged Patio Doors – Operating or Matching Stationary Units

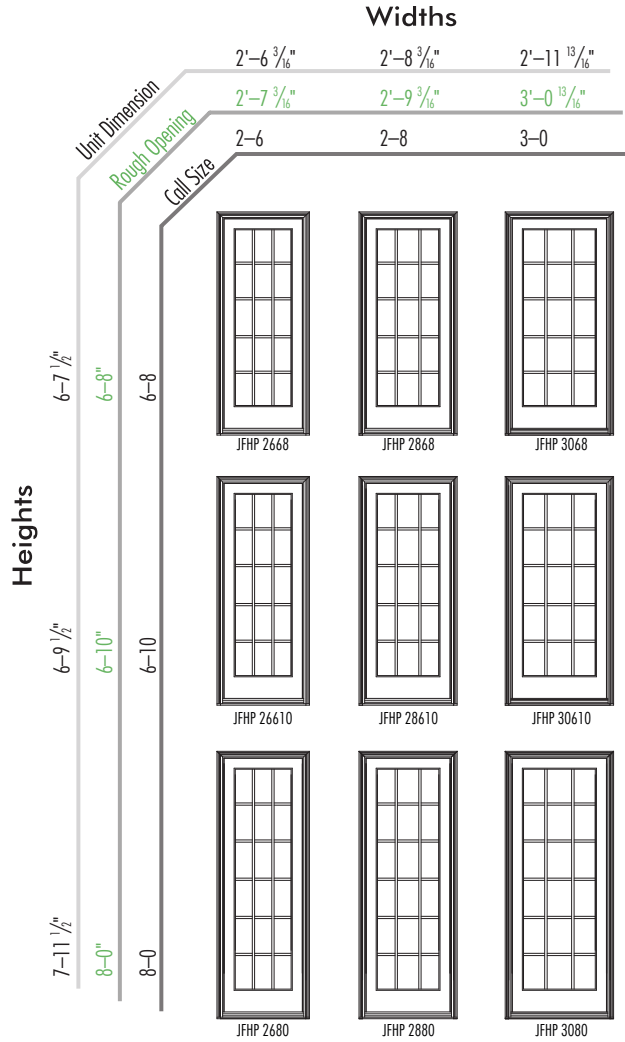



NOTE: Add the suffix "X" to the end of the above unit numbers to designate operating units.

Center Hinged Patio Doors – Transom Units

MW PRO SERIES 400, 300, 200

		Widths				
		4'-11 7/16"	5'-3 7/16"	5'-10 1/16"	7'-10 5/8"	8'-9 7/16"
		5'-0 7/16"	5'-4 7/16"	5'-11 1/16"	7'-11 5/8"	8'-10 9/16"
		5-0	5-4	6-0	8-0	9-0
Heights	Unit Dimension	0-11 3/4"				
	Rough Opening	0-11 7/8"				
Call Size	0-10	0-10				
	1-1 3/8"	1-1 7/8"				
1-3 3/8"	1-2	1-2				
	2-2 5/8"	2-3 1/8"				
2-6 5/8"	2-4	2-4				
		 JFHP50010TN	 JFHP54010TN	 JFHP60010TN	 JFHP80010TN	 JFHP90010TN
		 JFHP50010SGTN	 JFHP54010SGTN	 JFHP60010SGTN	 JFHP80010SGTN	 JFHP90010SGTN
		 JFHP5010TN	 JFHP5410TN	 JFHP6010TN	 JFHP8010TN	 JFHP9010TN
		 JFHP5010SGTN	 JFHP5410SGTN	 JFHP6010SGTN	 JFHP8010SGTN	 JFHP9010SGTN
		 JFHP5012TN	 JFHP5412TN	 JFHP6012TN	 JFHP8012TN	 JFHP9012TN
		 JFHP5012SGTN	 JFHP5412SGTN	 JFHP6012SGTN	 JFHP8012SGTN	 JFHP9012SGTN
		 JFHP5020TN	 JFHP5420TN	 JFHP6020TN	 JFHP8020TN	 JFHP9020TN
		 JFHP5020SGTN	 JFHP5420SGTN	 JFHP6020SGTN	 JFHP8020SGTN	 JFHP9020SGTN
		 JFHP5024TN	 JFHP5424TN	 JFHP6024TN	 JFHP9024TN	 JFHP9024TN
		 JFHP5024SGTN	 JFHP5424SGTN	 JFHP6024SGTN	 JFHP9024SGTN	 JFHP9024SGTN
		 JFHP5024SGTN	 JFHP5424SGTN	 JFHP6024SGTN	 JFHP9024SGTN	 JFHP9024SGTN

Heights	Widths		
	2'-6 3/8"	2'-8 3/8"	2'-11 13/16"
	2'-7 3/8"	2'-9 3/8"	3'-0 13/16"
	Unit Dimension	Unit Dimension	Unit Dimension
	Rough Opening	Rough Opening	Rough Opening
	Call Size	Call Size	Call Size
0-11 3/8"	0-11 7/8"	0-11 7/8"	0-10"
1-1 3/8"	1-1 7/8"	1-1 7/8"	1-0"
1-3 3/8"	1-3 7/8"	1-3 7/8"	1-2"
2-2 5/8"	2-3 1/8"	2-3 1/8"	2-0"
2-6 5/8"	2-7 1/8"	2-7 1/8"	2-4"
	JFHP26010TN	JFHP28010TN	JFHP30010TN
	JFHP2610TN	JFHP2810TN	JFHP3010TN
	JFHP2612TN	JFHP2812TN	JFHP3012TN
	JFHP2620TN	JFHP2820TN	JFHP3020TN
	JFHP2624TN	JFHP2824TN	JFHP3024TN
			

Standard Sliding Patio Door – Actual Unit Dimensions

MW PRO SERIES 400, 300, 200

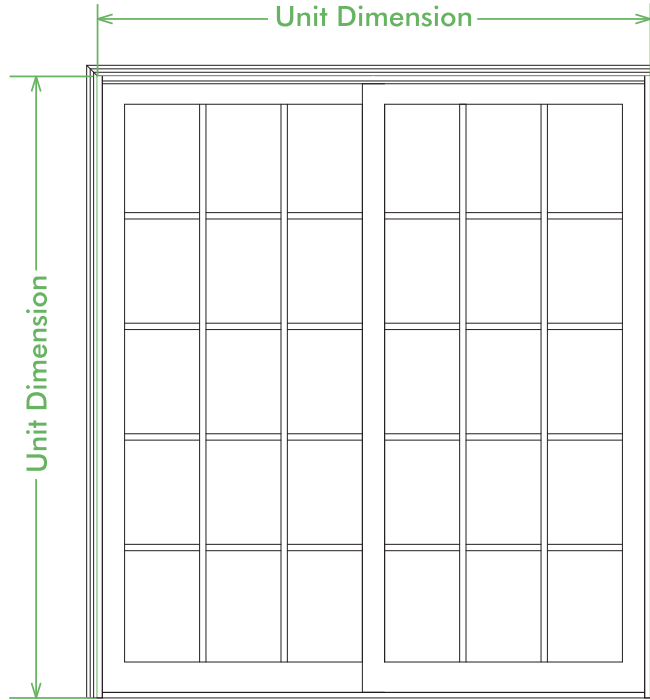

Door, Sidelight & Stationary Panel Units, HEIGHT

CALL SIZE (HEIGHT)	HEIGHT IN INCHES
6-8	79½
6-10	81½

Door, Stationary Panel & Single Transom Units, WIDTH

CALL SIZE (WIDTH)	2-6	3-0	4-0	5-0	6-0	8-0	9-0
Width in Inches	32	37 ⁵ / ₈	50 ³ / ₈	59 ⁷ / ₁₆	70 ¹¹ / ₁₆	96 ³ / ₁₆	107 ⁷ / ₁₆

Transom Units, HEIGHT

CALL SIZE (HEIGHT)	HEIGHT IN INCHES
0-10	11 ³ / ₈
1-0	13 ³ / ₈
1-2	15 ³ / ₈
2-0	26 ⁵ / ₈
2-4	30 ⁵ / ₈

Twin Transom Units, WIDTH

CALL SIZE (WIDTH)	5-0	6-0	8-0
RIGHT SIDE (Width in Inches)	29 ⁹ / ₁₆	35 ³ / ₁₆	47 ¹⁵ / ₁₆
LEFT SIDE (Width in Inches)	29 ⁹ / ₁₆	35 ³ / ₁₆	47 ¹⁵ / ₁₆

9-0 Triple Transom Units, WIDTH

PANEL CONFIGURATION	LEFT	CENTER	RIGHT
SIA	36 ¹⁵ / ₁₆	34 ⁷ / ₈	35 ¹ / ₁₆
SAI	36 ¹⁵ / ₁₆	34 ⁷ / ₈	35 ¹ / ₁₆
AIS	35 ¹ / ₁₆	34 ⁷ / ₈	36 ¹⁵ / ₁₆
IAS	35 ¹ / ₁₆	34 ⁷ / ₈	36 ¹⁵ / ₁₆

DOOR OPERATION CONFIGURATION OPTIONS

EXTERIOR VIEW OF DOORS

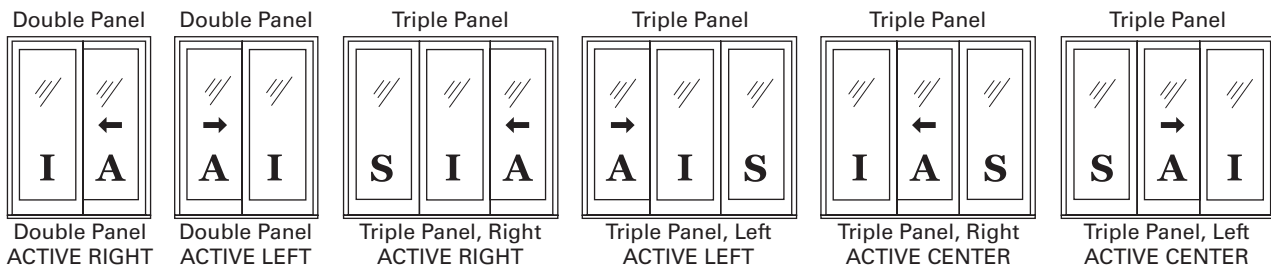

I=inactive panel

S=Fixed panel

A=active panel.

Standard Sliding Patio Door – Net Clear & Daylight Opening Dimensions

Door Units

Call Size	Clear Opening Width	Clear Opening Height	Clear Opening S.F.	Daylight Opening S.F.
WDSP5068	22.469	76.438	11.93	24.5
50610	22.469	78.438	12.24	25.2
6068	29.000	76.438	15.39	30.0
60610	29.000	78.438	15.80	30.9
8068	41.750	76.438	22.16	42.7
80610	41.750	78.438	22.74	43.8
9068	29.000	76.438	15.39	45.1
90610	29.000	78.438	15.80	46.3

Stationary Panel Units

Call Size	Daylight Opening S.F.
WDSP2668	12.4
610	12.7
WDSP3068	15.1
610	15.6
WDSP4068	21.4
610	22.0

Single Transom Units

Call Size	Daylight Opening S.F.
WDSPTN26010	1.8
10	2.2
12	2.6
20	4.9
24	5.8
WDSPTN30010	2.2
10	2.7
12	3.1
20	5.9
24	6.9
WDSPTN40010	3.0
10	3.6
12	4.3
20	8.0
24	9.4
WDSPTN50010	3.5
10	4.3
12	5.1
20	9.5
24	11.1
WDSPTN60010	4.2
10	5.1
12	6.1
20	11.4
24	13.3
WDSPTN80010	5.8
10	7.1
12	8.4
20	15.7
24	18.3
WDSPTN9010	7.9
12	9.4
20	17.6
24	20.5

Twin Transom Units

Call Size	Daylight Opening S.F.
WDSPTN50010	1.7
10	2.0
12	2.4
20	4.5
24	5.3
WDSPTN60010	2.0
10	2.5
12	2.9
20	5.5
24	6.4
WDSPTN80010	2.8
10	3.4
12	4.1
20	7.6
24	8.9

9-0 Triple Transom Units

PANEL CONFIGURATION*	Call Size	Daylight Opening S.F.
S (stationary panel)	WDSPTN90010	2.1
	10	2.6
	12	3.1
	20	5.8
	24	6.7
I (inactive panel)	WDSPTN90010	2.0
	10	2.5
	12	2.9
	20	5.5
	24	6.4
A (active panel)	WDSPTN90010	2.0
	10	2.4
	12	2.9
	20	5.4
	24	6.3

* See opposite page for panel configuration explanation.

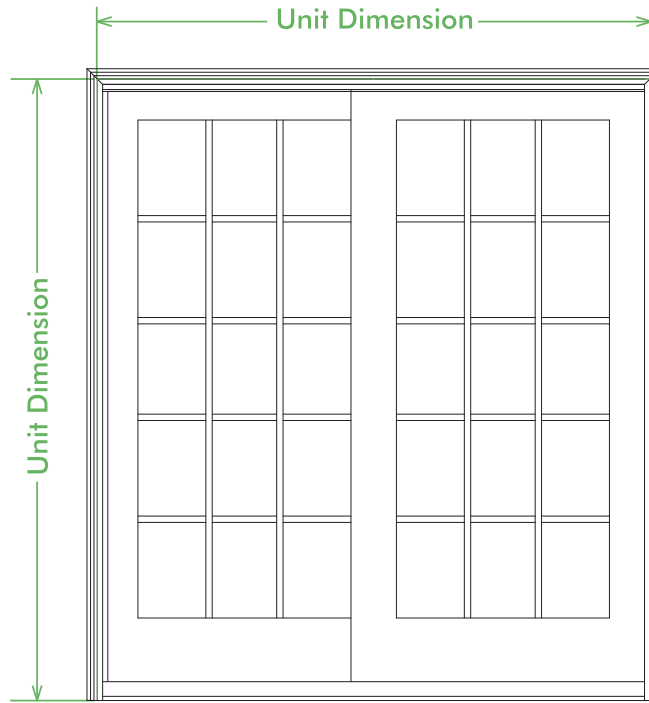

Door, Sidelight & Stationary Panel Units, HEIGHT

CALL SIZE (HEIGHT)	HEIGHT IN INCHES
6-8	79½
6-10	81½
8-0	95½

Door & Stationary Panel Units, WIDTH

CALL SIZE (WIDTH)	2-6	3-0	5-0	6-0	9-0
Width in Inches	32	37 ⁵ / ₈	59 ⁷ / ₁₆	70 ¹¹ / ₁₆	107 ⁵ / ₈

Single Transom Units, WIDTH

CALL SIZE (WIDTH)	2-6	3-0	5-0	6-0	9-0
Width in Inches	32	37 ⁵ / ₈	59 ⁷ / ₁₆	70 ¹¹ / ₁₆	107 ⁵ / ₈

Transom Units, HEIGHT

CALL SIZE (HEIGHT)	HEIGHT IN INCHES
0-10	11 ³ / ₈
1-0	13 ³ / ₈
1-2	15 ³ / ₈
2-0	26 ⁵ / ₈
2-4	30 ⁵ / ₈

Twin Transom Units, WIDTH

CALL SIZE (WIDTH)	5-0	6-0
RIGHT SIDE (Width in Inches)	29 ⁹ / ₁₆	35 ³ / ₁₆
LEFT SIDE (Width in Inches)	29 ⁹ / ₁₆	35 ³ / ₁₆

9-0 Triple Transom Units, WIDTH

PANEL CONFIGURATION	LEFT	CENTER	RIGHT
SIA	36 ¹⁵ / ₁₆	34 ⁷ / ₈	35 ¹ / ₁₆
SAI	36 ¹⁵ / ₁₆	34 ⁷ / ₈	35 ¹ / ₁₆
AIS	35 ¹ / ₁₆	34 ⁷ / ₈	36 ¹⁵ / ₁₆
IAS	35 ¹ / ₁₆	34 ⁷ / ₈	36 ¹⁵ / ₁₆

DOOR OPERATION CONFIGURATION OPTIONS EXTERIOR VIEW OF DOORS

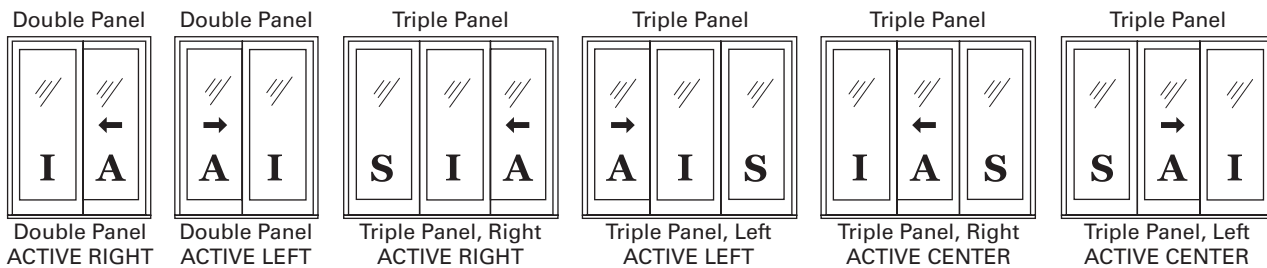

I=inactive panel

S=Fixed panel

A=active panel.

French Sliding Patio Door – Net Clear & Daylight Opening Dimensions

Door Units

Call Size	Clear Opening Width	Clear Opening Height	Clear Opening S.F.	Daylight Opening S.F.
WDFS5068	22.000	76.438	11.68	19.1
50610	22.000	78.438	11.98	19.7
5080	22.000	92.438	14.12	23.9
6068	28.500	76.438	15.13	24.1
60610	28.500	78.438	15.52	24.8
6080	28.500	92.438	18.29	30.1
8068	22.000	76.438	11.68	36.1
80610	22.000	78.438	11.98	37.2
8080	22.000	92.438	14.12	45.2

Stationary Panel Units

Call Size	Daylight Opening S.F.
WDFS2668	9.6
610	9.9
80	12.0
WDFS3068	12.0
610	12.4
80	15.1

Single Transom Units

Call Size	Daylight Opening S.F.
WDSPTN26010	1.8
10	2.2
12	2.6
20	4.9
24	5.8
WDSPTN30010	2.2
10	2.7
12	3.1
20	5.9
24	6.9
WDSPTN40010	3.0
10	3.6
12	4.3
20	8.0
24	9.4
WDSPTN50010	3.5
10	4.3
12	5.1
20	9.5
24	11.1
WDSPTN60010	4.2
10	5.1
12	6.1
20	11.4
24	13.3
WDSPTN80010	5.8
10	7.1
12	8.4
20	15.7
24	18.3
WDSPTN9010	7.9
12	9.4
20	17.6
24	20.5

Twin Transom Units

Call Size	Daylight Opening S.F.
WDSPTN50010	1.7
10	2.0
12	2.4
20	4.5
24	5.3
WDSPTN60010	2.0
10	2.5
12	2.9
20	5.5
24	6.4
WDSPTN80010	2.8
10	3.4
12	4.1
20	7.6
24	8.9

9-0 Triple Transom Units

PANEL CONFIGURATION*	Call Size	Daylight Opening S.F.
S (stationary panel)	WDSPTN90010	2.1
	10	2.6
	12	3.1
	20	5.8
I (inactive panel)	24	6.7
	WDSPTN90010	2.0
	10	2.5
	12	2.9
A (active panel)	20	5.5
	24	6.4
	WDSPTN90010	2.0
	10	2.4
12	2.9	
	20	5.4
	24	6.3

* See opposite page for panel configuration explanation.

Center Hinged Patio Door – Actual Unit Dimensions

MW PRO SERIES 400, 300, 200

Door, Sidelight & Stationary Panel Units, HEIGHT

CALL SIZE (HEIGHT)	HEIGHT IN INCHES
6-8	79½
6-10	81½
8-0	95½

Transom Units, HEIGHT

CALL SIZE (HEIGHT)	HEIGHT IN INCHES
0-10	11¾
1-0	13¾
1-2	15¾
2-0	26¾
2-4	30¾

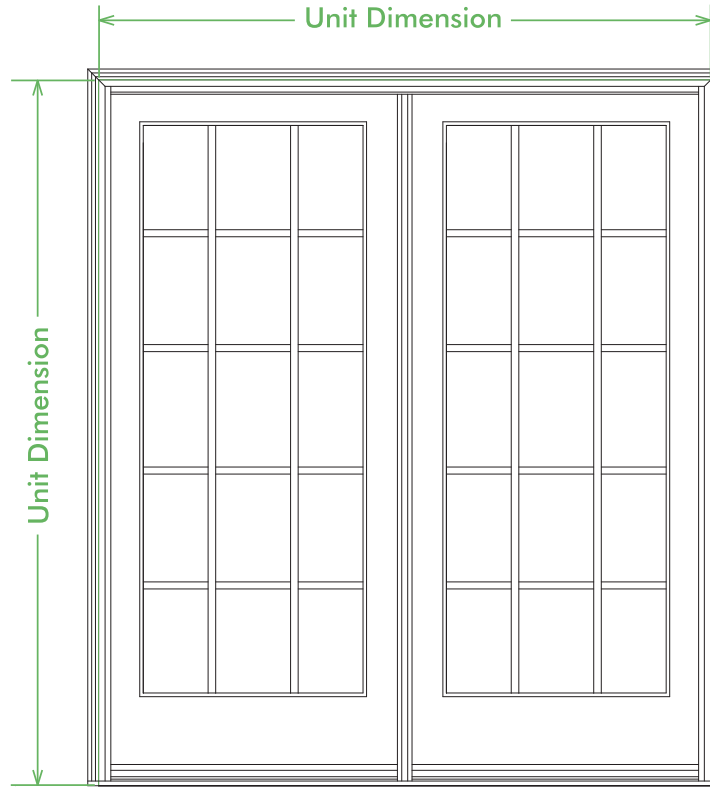

Door, Stationary Panel & Single Transom Units, WIDTH

CALL SIZE (WIDTH)	2-6	2-8	3-0	5-0	5-4	6-0	8-0	9-0
Width in Inches	30¾/16	32¾/16	35¼/16	59¾/16	63¾/16	70¼/16	94¾/8	105¾/16

Twin Transom Units, WIDTH

CALL SIZE (WIDTH)	5-0	5-4	6-0
RIGHT SIDE (Width in Inches)	29¾/16	31¾/16	35¾/16
LEFT SIDE (Width in Inches)	29¾/16	31¾/16	35¾/16

8-0 Triple Transom Units, WIDTH

PANEL CONFIGURATION	LEFT	CENTER	RIGHT
OXO	31¾/16	30¼/16	31¾/16
XOO	30¼/16	31¾/16	31¾/16
OOX	31¾/16	31¾/16	30¼/16

9-0 Triple Transom Units, WIDTH

PANEL CONFIGURATION	LEFT	CENTER	RIGHT
OXO	35¾/16	34¼/16	35¾/16
XOO	34¼/16	35¾/16	35¾/16
OOX	35¾/16	35¾/16	34¼/16

DOOR OPERATION CONFIGURATION OPTIONS

EXTERIOR VIEW OF DOORS

Single Panel



Double Panel

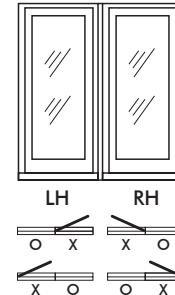

Triple Panel

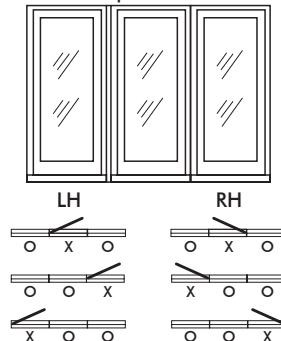

O=Stationary panel
X= Operable panel
LH=Left hand swing
RH=Right hand swing

Center Hinged Patio Door – Net Clear & Daylight Opening Dimensions

Door Units

Call Size	Clear Opening Width	Clear Opening Height	Clear Opening S.F.	Daylight Opening S.F.
WDHP2668X	27.531	76.313	14.59	8.7
26610X	27.531	78.313	14.97	9.0
2680X	27.531	92.313	17.65	10.9
WDHP2868X	29.531	76.313	15.65	9.6
28610X	29.531	78.313	16.06	9.9
2880X	29.531	92.313	18.93	12.0
WDHP3068X	33.156	76.313	17.57	11.2
30610X	33.156	78.313	18.03	11.5
3080	33.156	92.313	21.26	14.0
WDHP5068	27.531	76.313	14.59	17.4
50610	27.531	78.313	14.97	17.9
5080	27.531	92.313	17.65	21.8

Call Size	Clear Opening Width	Clear Opening Height	Clear Opening S.F.	Daylight Opening S.F.
WDHP5468	29.531	76.313	15.65	19.1
54610	29.531	78.313	16.06	19.7
5480	29.531	92.313	18.93	24.0
WDHP6068	33.156	76.313	17.57	22.3
60610	33.156	78.313	18.03	23.0
6080	33.156	92.313	21.26	28.0
WDHP9068	33.156	76.313	17.57	33.5
90610	33.156	78.313	18.03	34.6
9080	33.156	92.313	21.26	42.0

Stationary Panel Units

Call Size	Daylight Opening S.F.
WDHP2668	8.7
610	9.0
80	10.9
WDHP2868	9.6
610	9.9
80	12.0
WDHP3068	11.2
610	11.5
80	14.0

Single Transom Units

Call Size	Daylight Opening S.F.
WDSPTN26010	1.7
10	2.1
12	2.5
20	4.6
24	5.4
WDSPTN28010	1.8
10	2.2
12	2.7
20	5.0
24	5.8

Call Size	Daylight Opening S.F.
WDSPTN30010	2.1
10	2.5
12	3.0
20	5.6
24	6.5
WDSPTN50010	3.5
10	4.3
12	5.1
20	9.5
24	11.1

Call Size	Daylight Opening S.F.
WDSPTN54010	3.8
10	4.6
12	5.4
20	10.2
24	11.9
WDSPTN60010	4.2
10	5.1
12	6.1
20	11.4
24	13.3

Call Size	Daylight Opening S.F.
WDSPTN80010	5.7
10	7.0
12	8.2
20	15.4
24	18.0
WDSPTN90010	6.4
10	7.8
12	9.2
20	17.3
24	20.1

Twin Transom Units

Call Size	Daylight Opening S.F.
WDSPTN50010	1.7
10	2.0
12	2.4
20	4.5
24	5.3
WDSPTN54010	1.8
10	2.2
12	2.6
20	4.9
24	5.7
WDSPTN60010	2.0
10	2.5
12	2.9
20	5.5
24	6.4

Triple Transom Units

PANEL CONFIGURATION*	Call Size	Daylight Opening S.F.
XOO OR OOX	WDSPTN80010	1.8
	10	2.2
	12	2.6
	20	4.9
OXO	24	5.7
	WDSPTN80010	1.8
	10	2.1
	12	2.5
OXO	20	4.8
	24	5.6

PANEL CONFIGURATION*	Call Size	Daylight Opening S.F.
XOO OR OOX	WDSPTN90010	2.0
	10	2.5
	12	2.9
	20	5.5
OXO	24	6.4
	WDSPTN90010	2.0
	10	2.4
	12	2.9
OXO	20	5.4
	24	6.3

* See opposite page for panel configuration explanation.



Windows Siding Stone Veneer Fence+Rail Designer Accents plygem.com



Ply Gem, the Ply Gem logo, the "Building Products. Building Success." slogan, Ply Gem Windows and the Ply Gem Windows logo are trademarks of Ply Gem Industries, Inc. ©2009 Ply Gem Industries, Inc.